

Timber Towers

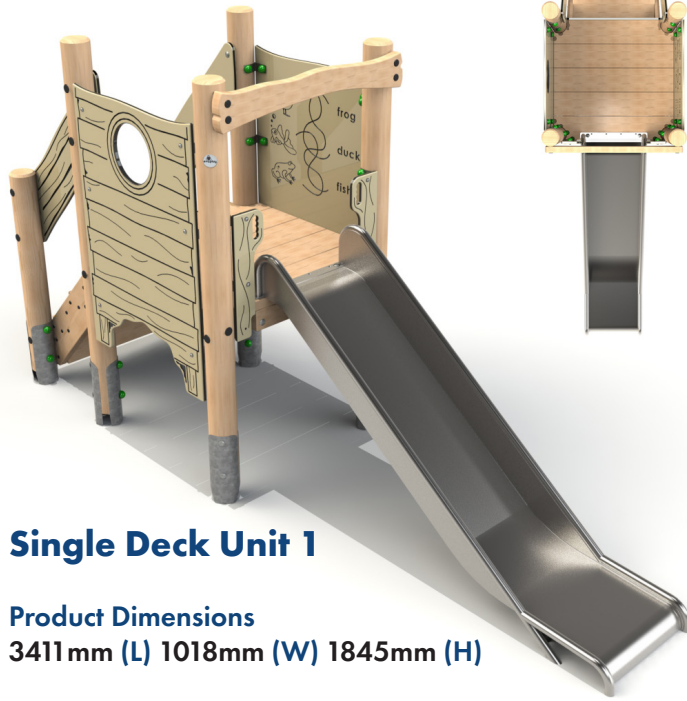

RSJ PLAY

Timber Towers



Single Deck Unit 1

Product Dimensions
3411mm (L) 1018mm (W) 1845mm (H)

Minimum Surface Area: 23.52m²
6878mm (L) 4018mm (W)

Free Fall Height: 900mm



Single Deck Unit 3

Product Dimensions
3620mm (L) 2147mm (W) 3201mm (H)

Minimum Surface Area: 26.44m²
7073mm (L) 5140mm (W)

Free Fall Height: 1200mm



Single Deck Unit 2

Product Dimensions
4145mm (L) 1082mm (W) 3147mm (H)

Minimum Surface Area: 25.61m²
7614mm (L) 4018mm (W)

Free Fall Height: 1200mm

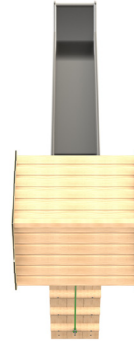

Single Deck Unit 4

Product Dimensions
5550mm (L) 2094mm (W)
2970mm (H)

Minimum Surface Area: 32.97m²
8984mm (L) 5102mm (W)

Free Fall Height: 1500mm

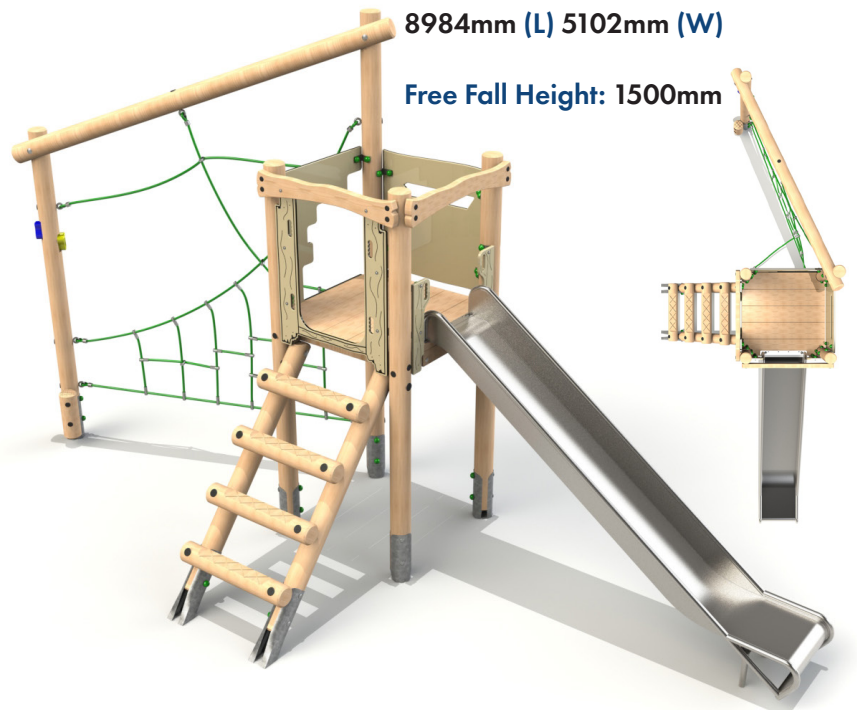

Bespoke Towers available, enquire for more information.

Timber Towers

Double Deck Unit 1

Product Dimensions

5837mm (L) 2717mm (W) 2320mm (H)

Minimum Surface Area: 37.48m²

9289mm (L) 5706mm (W)

Free Fall Height: 1327mm



Double Deck Unit 2

Product Dimensions

5744mm (L) 4145mm (W) 2310mm (H)

Minimum Surface Area: 45.82m²

8734mm (L) 7614mm (W)

Free Fall Height: 1200mm

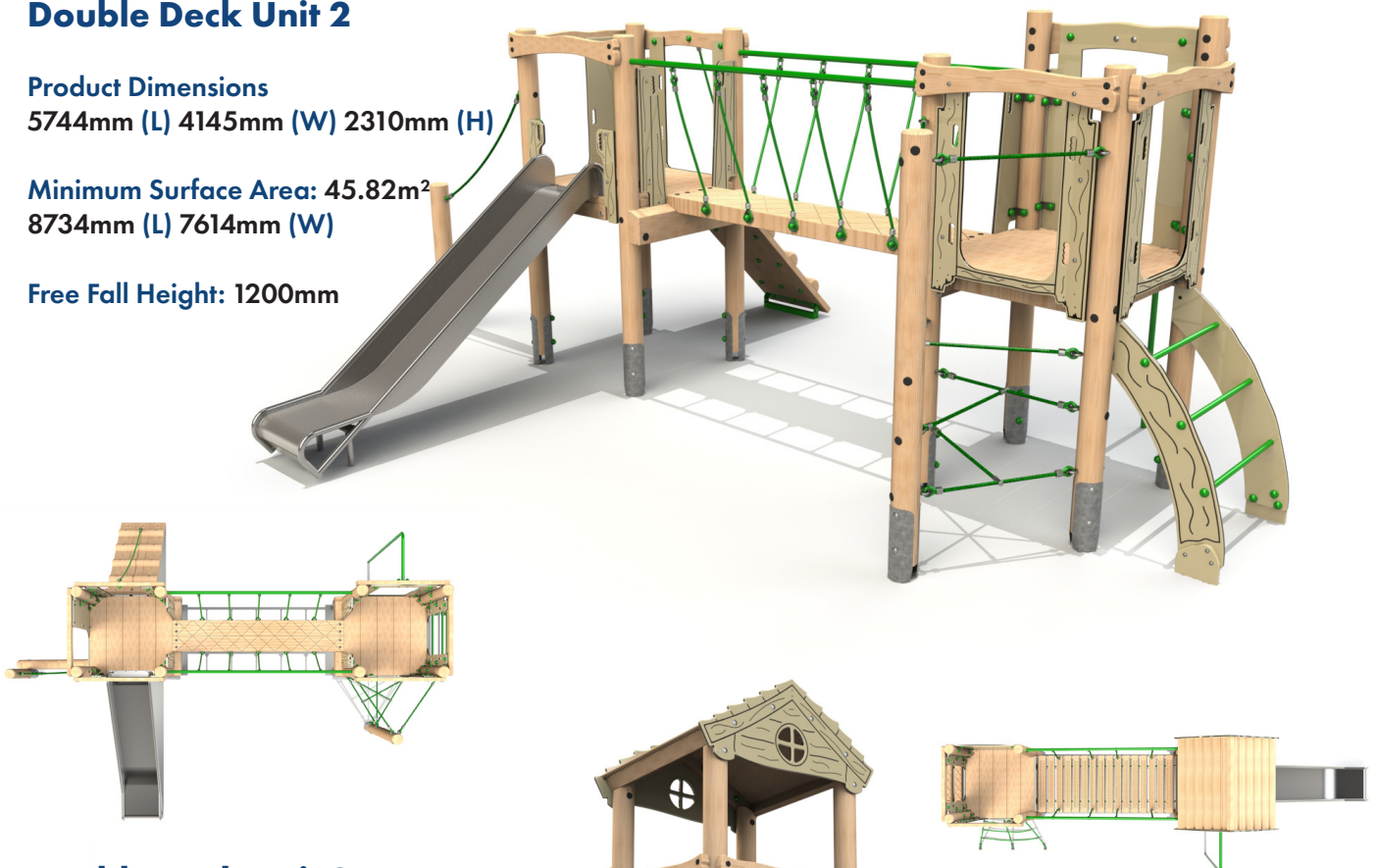

Double Deck Unit 3

Product Dimensions

6613mm (L) 1669mm (W) 3149mm (H)

Minimum Surface Area: 39.05m²

10082mm (L) 4607mm (W)

Free Fall Height: 1200mm



Steel feet as standard, bespoke rope colours available.

Timber Towers

Double Deck Unit 4

Product Dimensions

7507mm (L) 1835mm (W) 3501mm (H)

Minimum Surface Area: 40.61m²

10976mm (L) 4791mm (W)

Free Fall Height: 1500mm

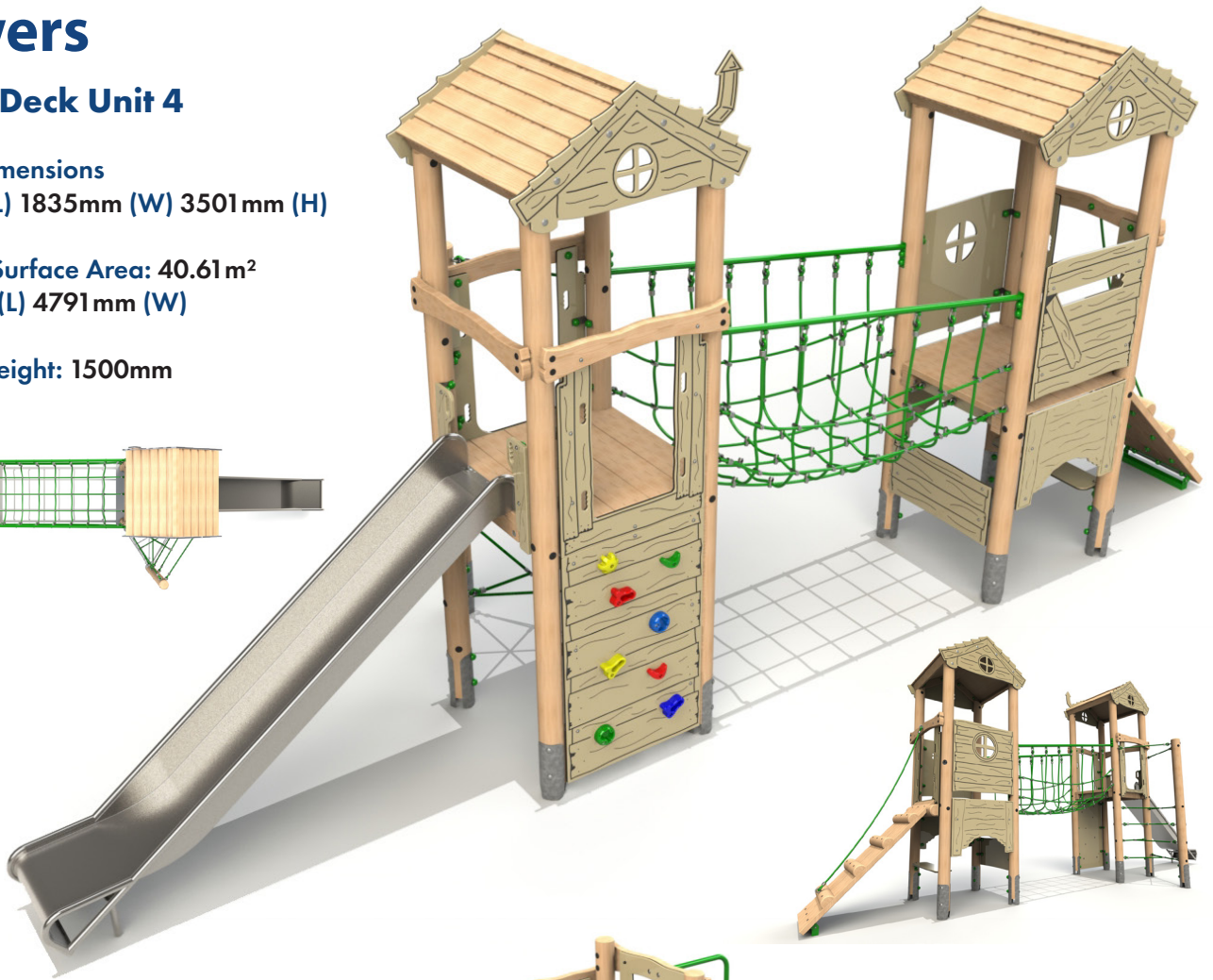
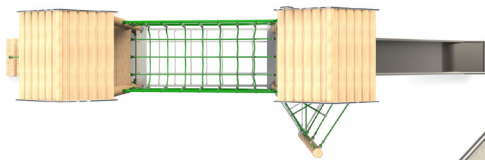

Double Deck Unit 5

Product Dimensions

5124mm (L) 4183mm (W) 2945mm (H)

Minimum Surface Area: 50.04m²

8592mm (L) 7236mm (W)

Free Fall Height: 1800mm



Bespoke Towers available, enquire for more information.

Alt Double Deck Unit 1

Product Dimensions

4678mm (L) 3090mm (W) 3149mm (H)

Minimum Surface Area: 34.61m²

8136mm (L) 6143mm (W)

Free Fall Height: 1200mm

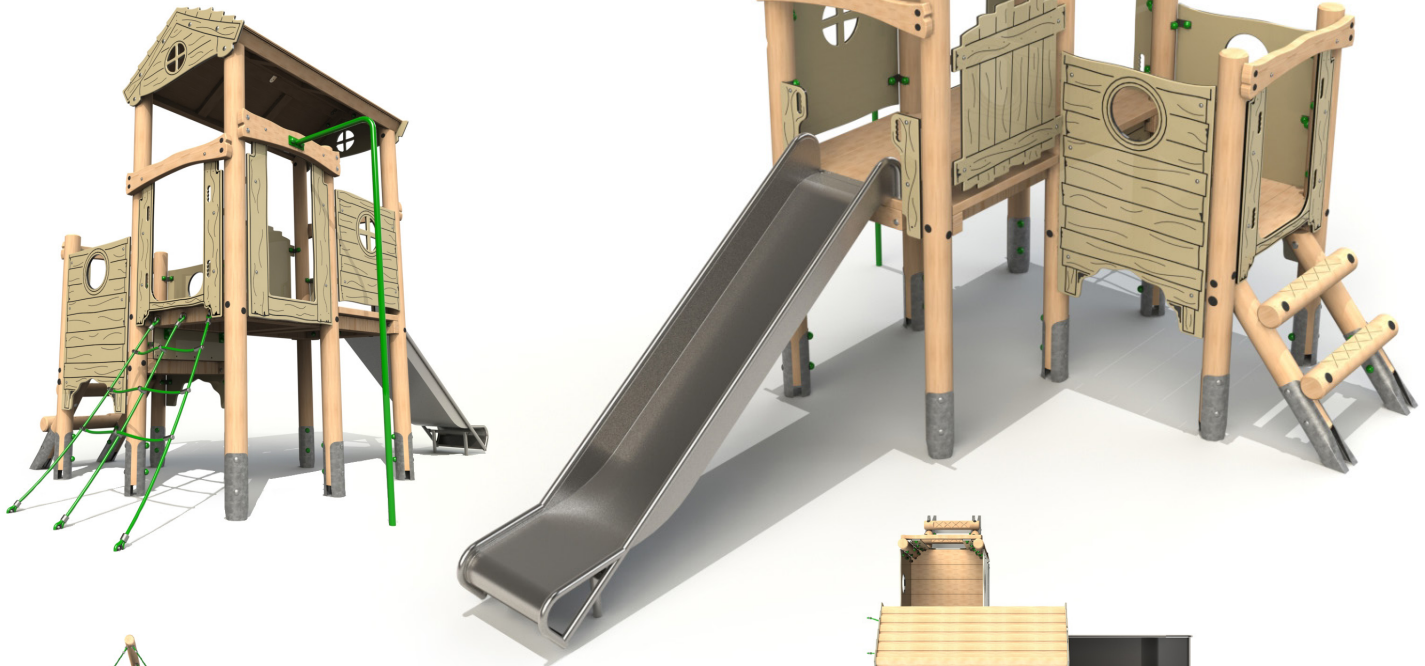

Alt Double Deck Unit 2

Product Dimensions

5711mm (L) 3099mm (W) 3799mm (H)

Minimum Surface Area: 36.67m²

9173mm (L) 6082mm (W)

Free Fall Height: 1800mm



Steel feet as standard, bespoke rope colours available.

Timber Towers

Alt Double Deck Unit 3

Product Dimensions

6706mm (L) 2841mm (W) 2605mm (H)

Minimum Surface Area: 41.6m²

10175mm (L) 5813mm (W)

Free Fall Height: 1500mm

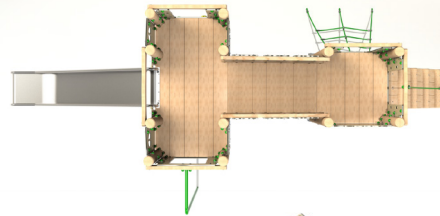
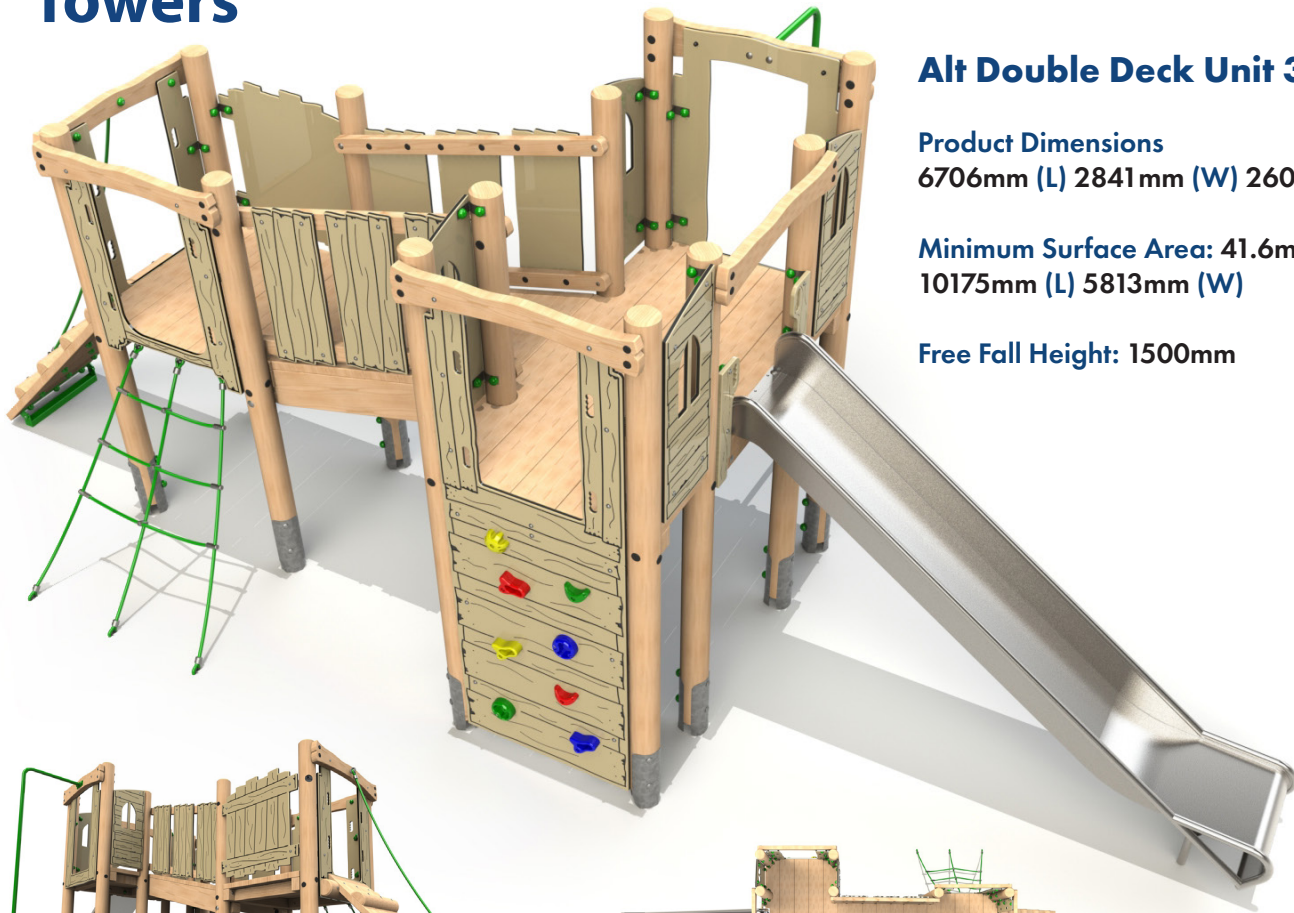

Alt Double Deck Unit 4

Product Dimensions

4233mm (L) 3880mm (W) 3699mm (H)

Minimum Surface Area: 35.57m²

7363mm (L) 7216mm (W)

Free Fall Height: 1500mm

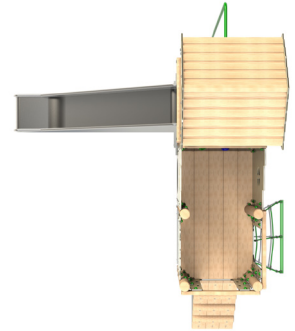
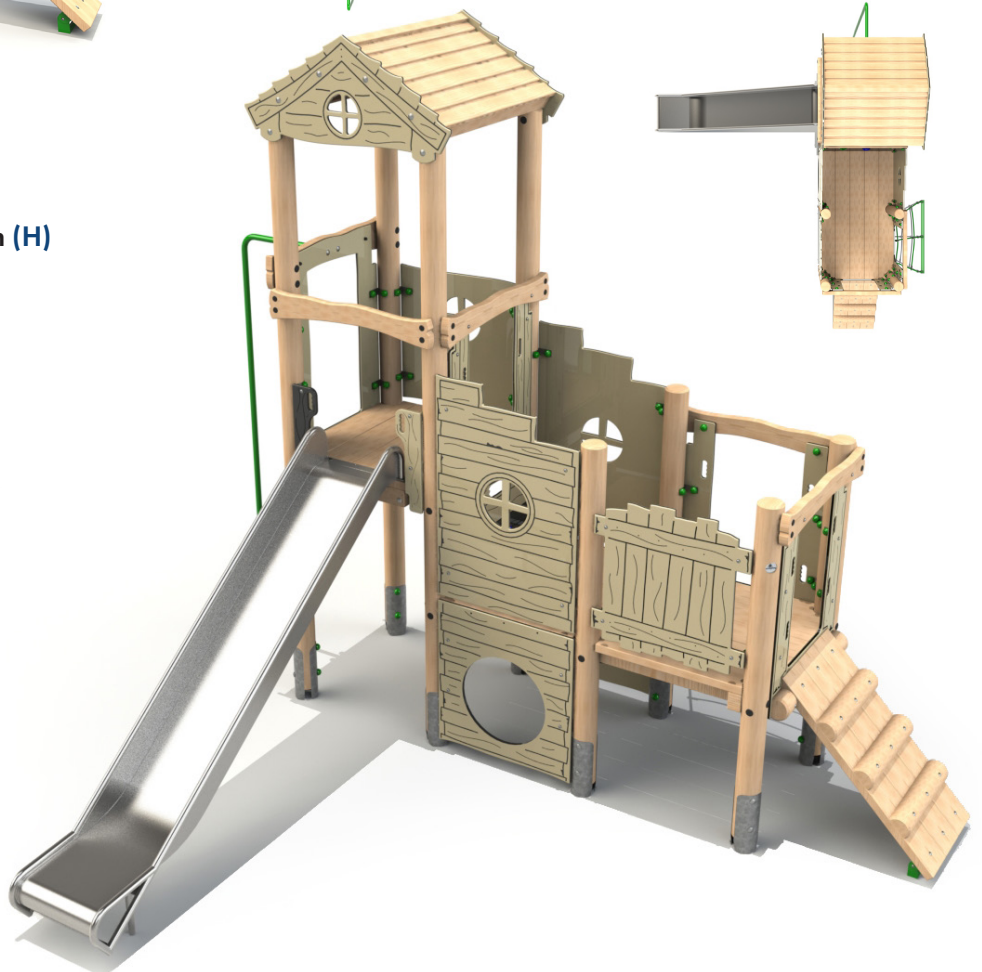

Bespoke Towers available, enquire for more information.

Triple Deck Unit 1

Product Dimensions

6638mm (L) 4081mm (W) 2310mm (H)

Minimum Surface Area: 52.58m²

10090mm (L) 7036mm (W)

Free Fall Height: 1200mm

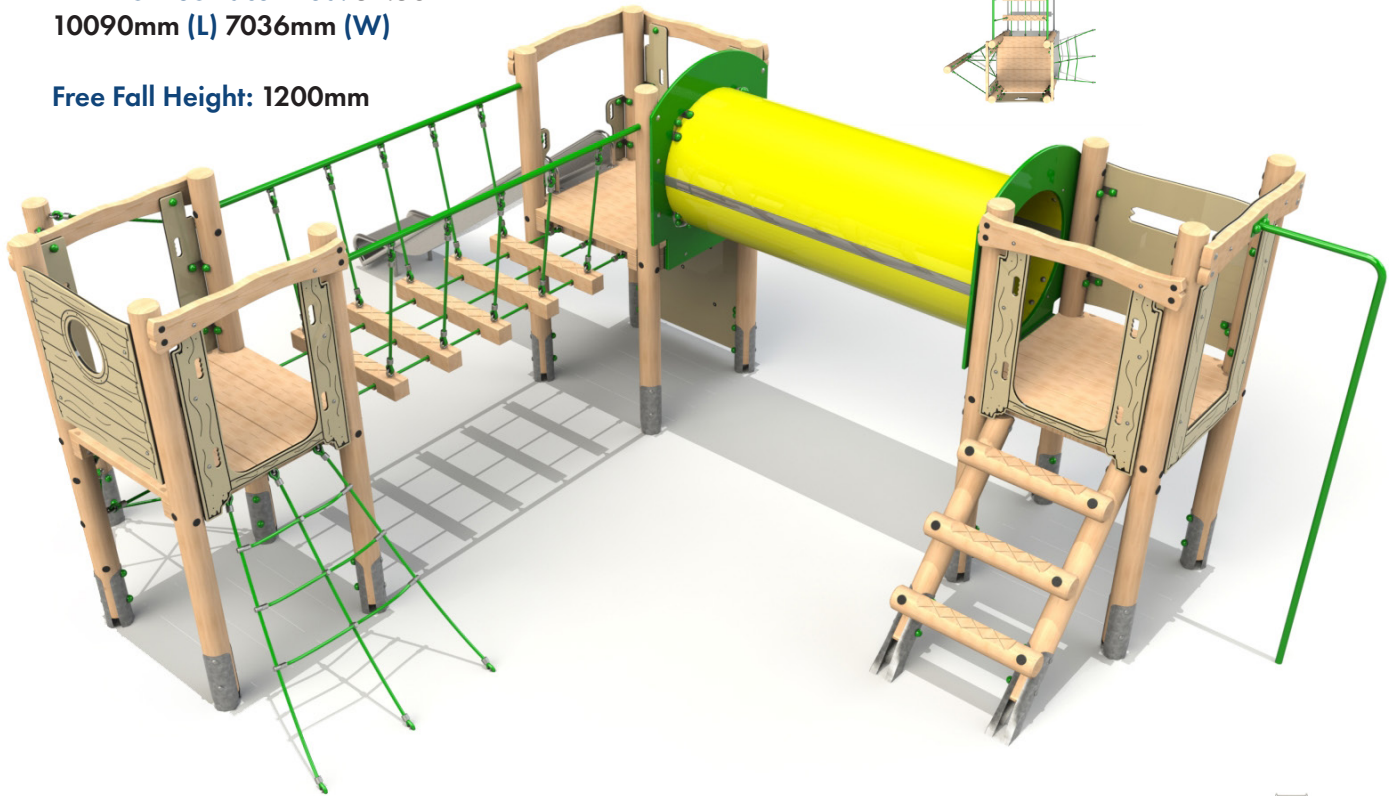
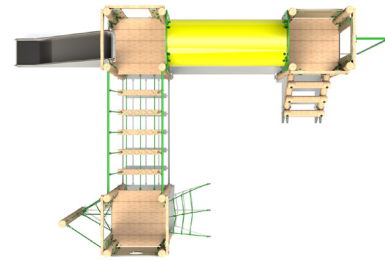

Triple Deck Unit 2

Product Dimensions

6377mm (L) 5803mm (W) 3699mm (H)

Minimum Surface Area: 53.78m²

9846mm (L) 8786mm (W)

Free Fall Height: 1500mm

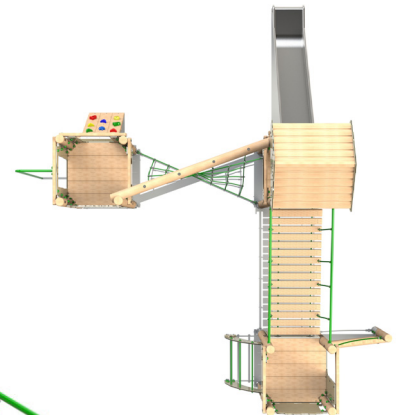

Steel feet as standard, bespoke rope colours available.

Timber Towers

Triple Deck Unit 3

Product Dimensions

7099mm (L) 4489mm (W) 3399mm (H)

Minimum Surface Area: 56.78m²

10054mm (L) 7958mm (W)

Free Fall Height: 1500mm



Triple Deck Unit 4

Product Dimensions

6982mm (L) 5059mm (W) 3449mm (H)

Minimum Surface Area: 54.83m²

10435mm (L) 7992mm (W)

Free Fall Height: 1677mm

Bespoke Towers available, enquire for more information.

Four Deck Unit 1

Product Dimensions

6546mm (L) 4664mm (W) 3149mm (H)

Minimum Surface Area: 58.06m²

9410mm (L) 7620mm (W)

Free Fall Height: 1200mm



Four Deck Unit 2

Product Dimensions

7508mm (L) 4630mm (W)

3501mm (H)

Minimum Surface Area: 69.74m²

10977mm (L) 7576mm (W)

Free Fall Height: 1500mm

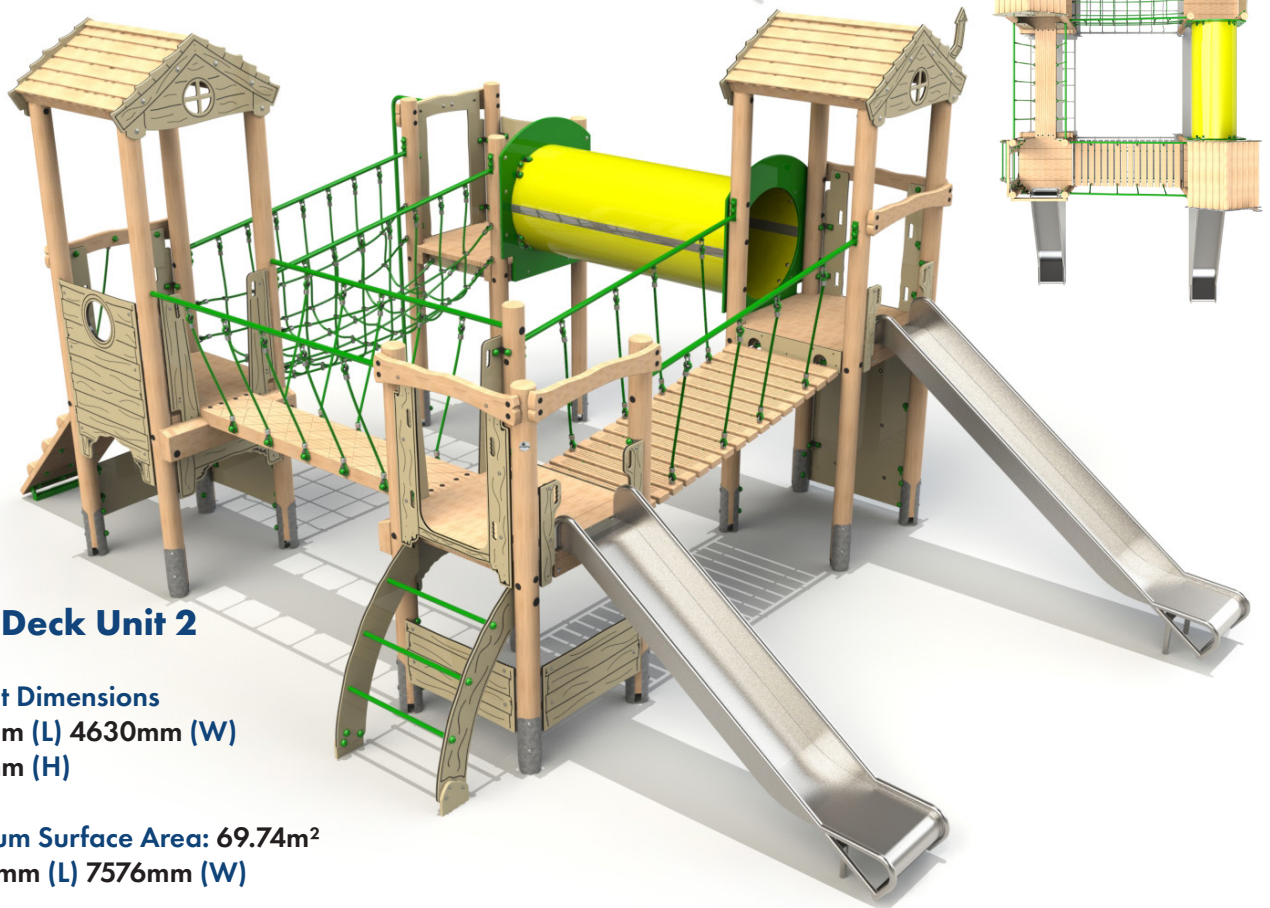

Timber Towers

Four Deck Unit 3

Product Dimensions

8194mm (L) 5243mm (W) 3449mm (H)

Minimum Surface Area: 74.33m²

11186mm (L) 8196mm (W)

Free Fall Height: 1500mm



Four Deck Unit 4

Product Dimensions

10371mm (L) 4131mm (W) 2970mm (H)

Minimum Surface Area: 62.32m²

13360mm (L) 7600mm (W)

Free Fall Height: 1500mm

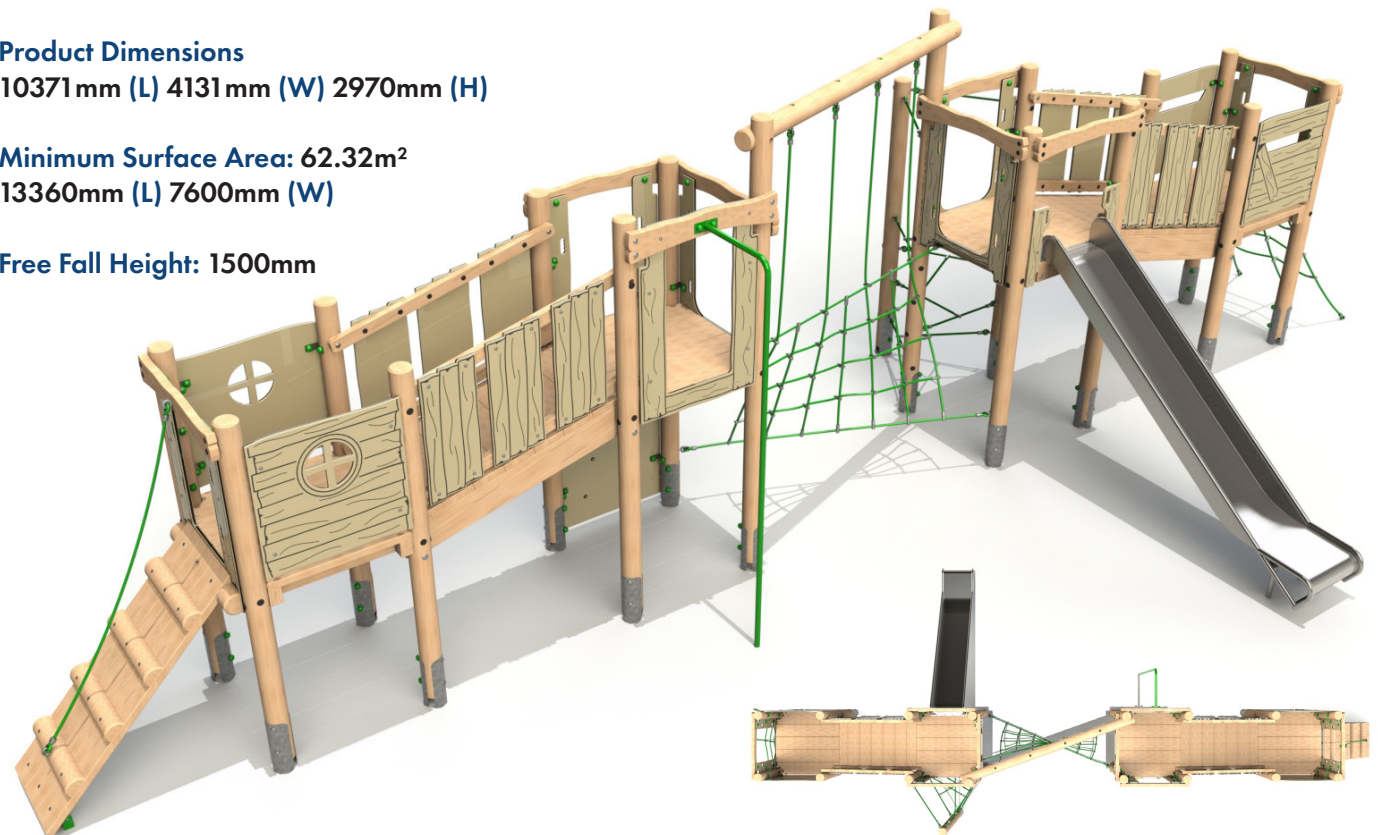

Bespoke Towers available, enquire for more information.

Alt Four Deck Unit 1

Product Dimensions

6313mm (L) 6107mm (W) 3799mm (H)

Minimum Surface Area: 63.92m²

9289mm (L) 9099mm (W)

Free Fall Height: 1895mm

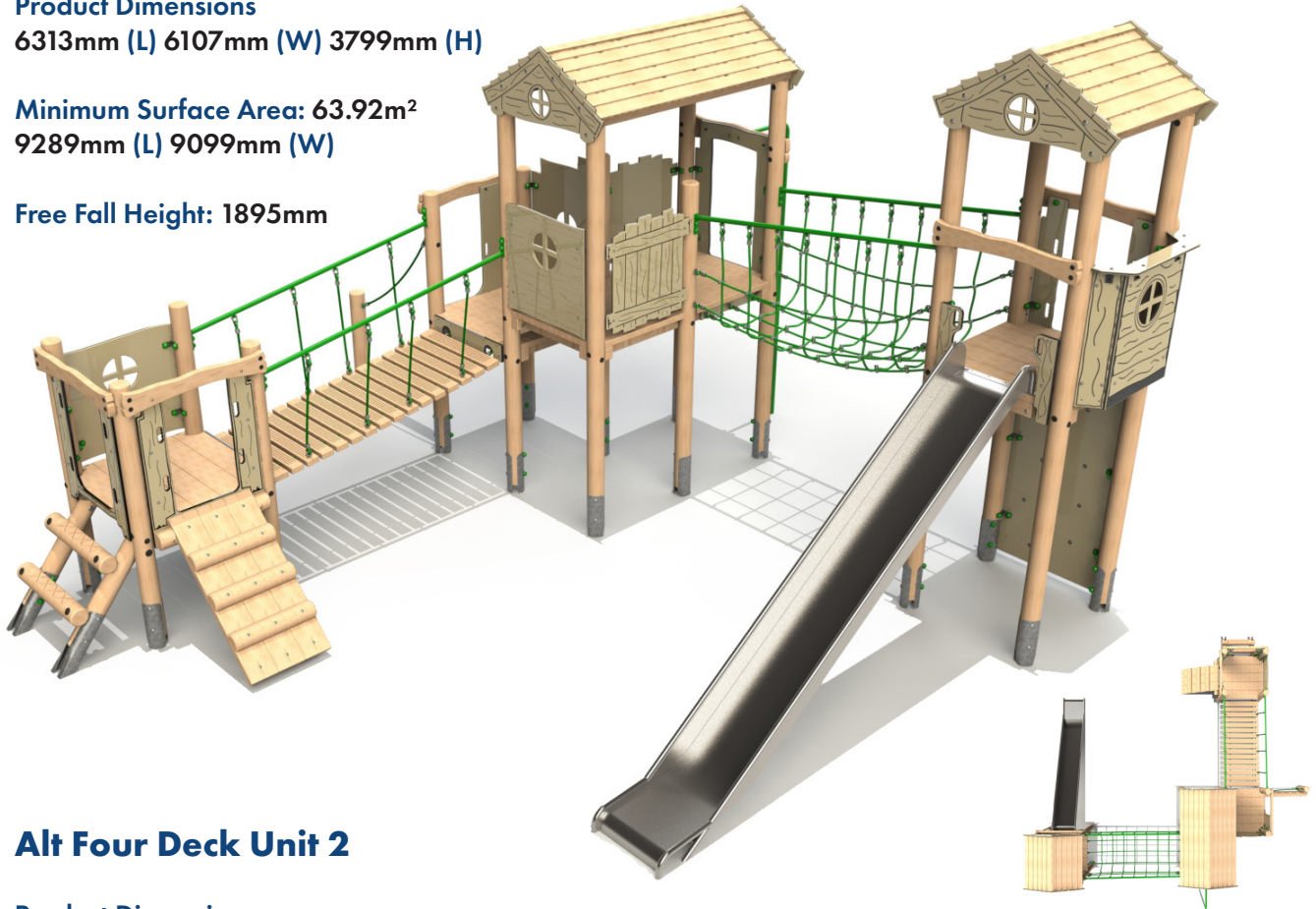

Alt Four Deck Unit 2

Product Dimensions

9403mm (L) 8049mm (W) 2905mm (H)

Minimum Surface Area: 79.2m²

13332mm (L) 11038mm (W)

Free Fall Height: 1800mm

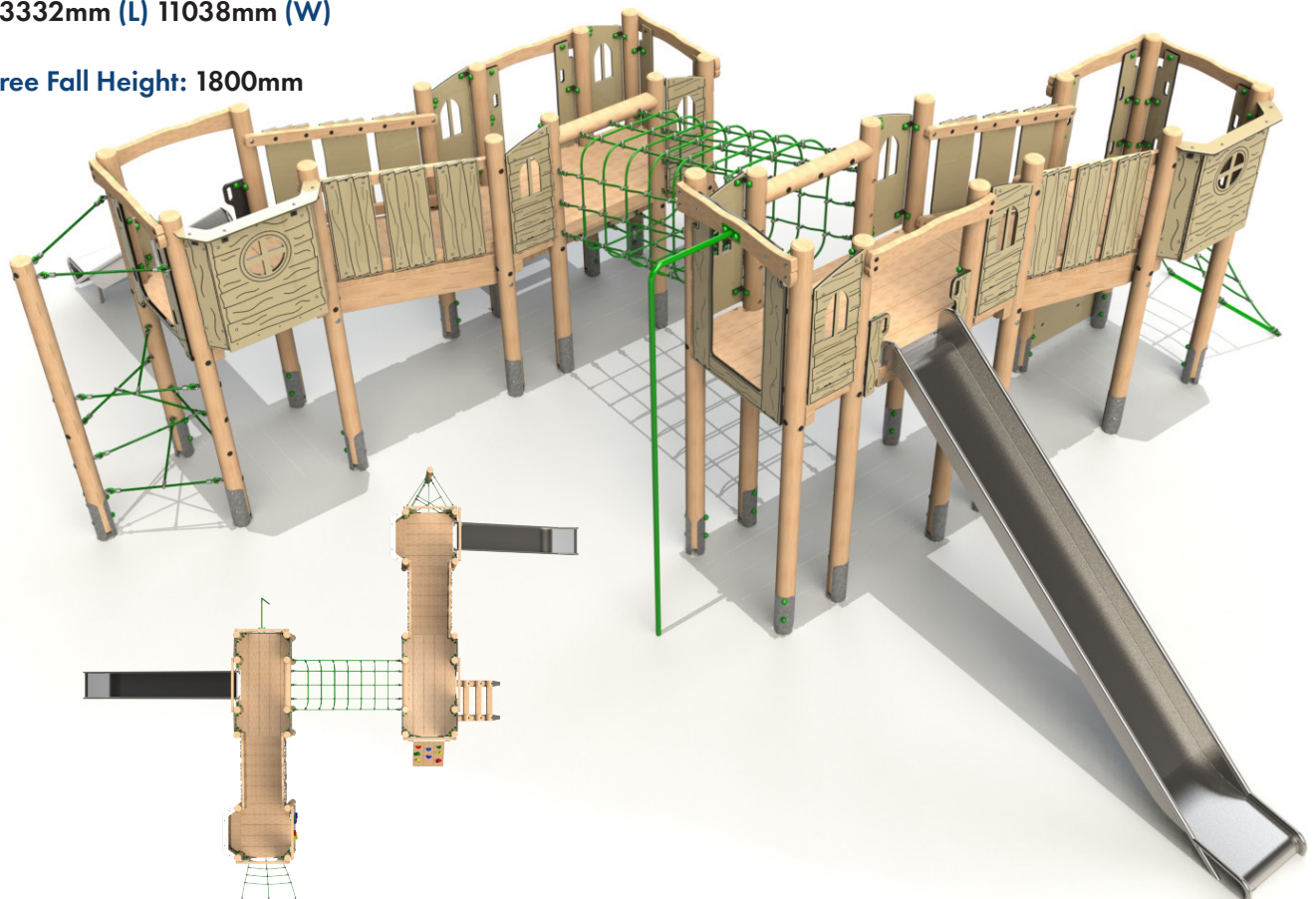

Steel feet as standard, bespoke rope colours available.

Timber Towers

Alt Four Deck Unit 3

Product Dimensions

7787mm (L) 5579mm (W) 2745mm (H)

Minimum Surface Area: 68.53m²

11249mm (L) 8718mm (W)

Free Fall Height: 1800mm

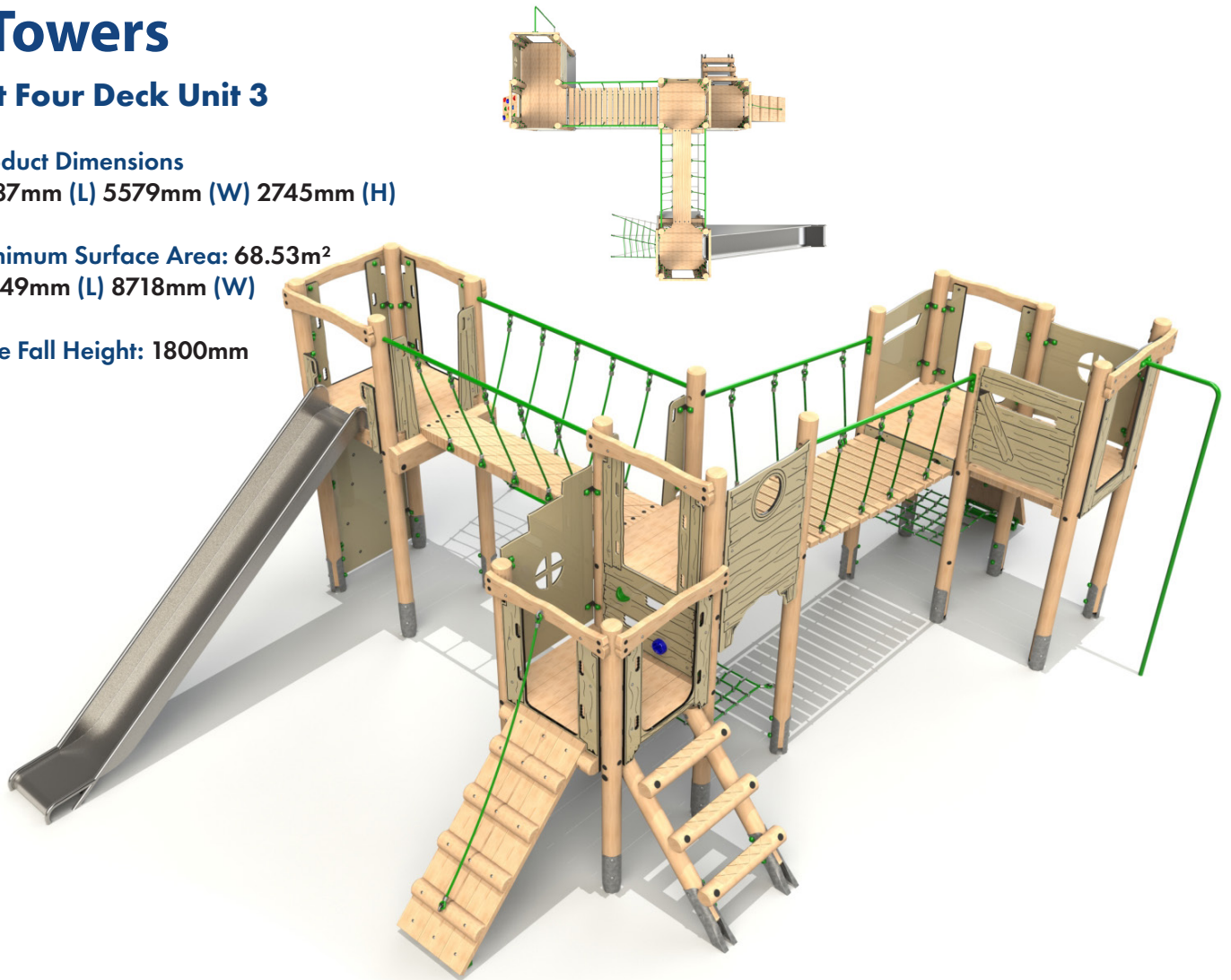

Castle Tower 1

Product Dimensions

3965mm (L) 2524mm (W) 3425mm (H)

Minimum Surface Area: 28.96m²

7408mm (L) 5449mm (W)

Free Fall Height: 1500mm

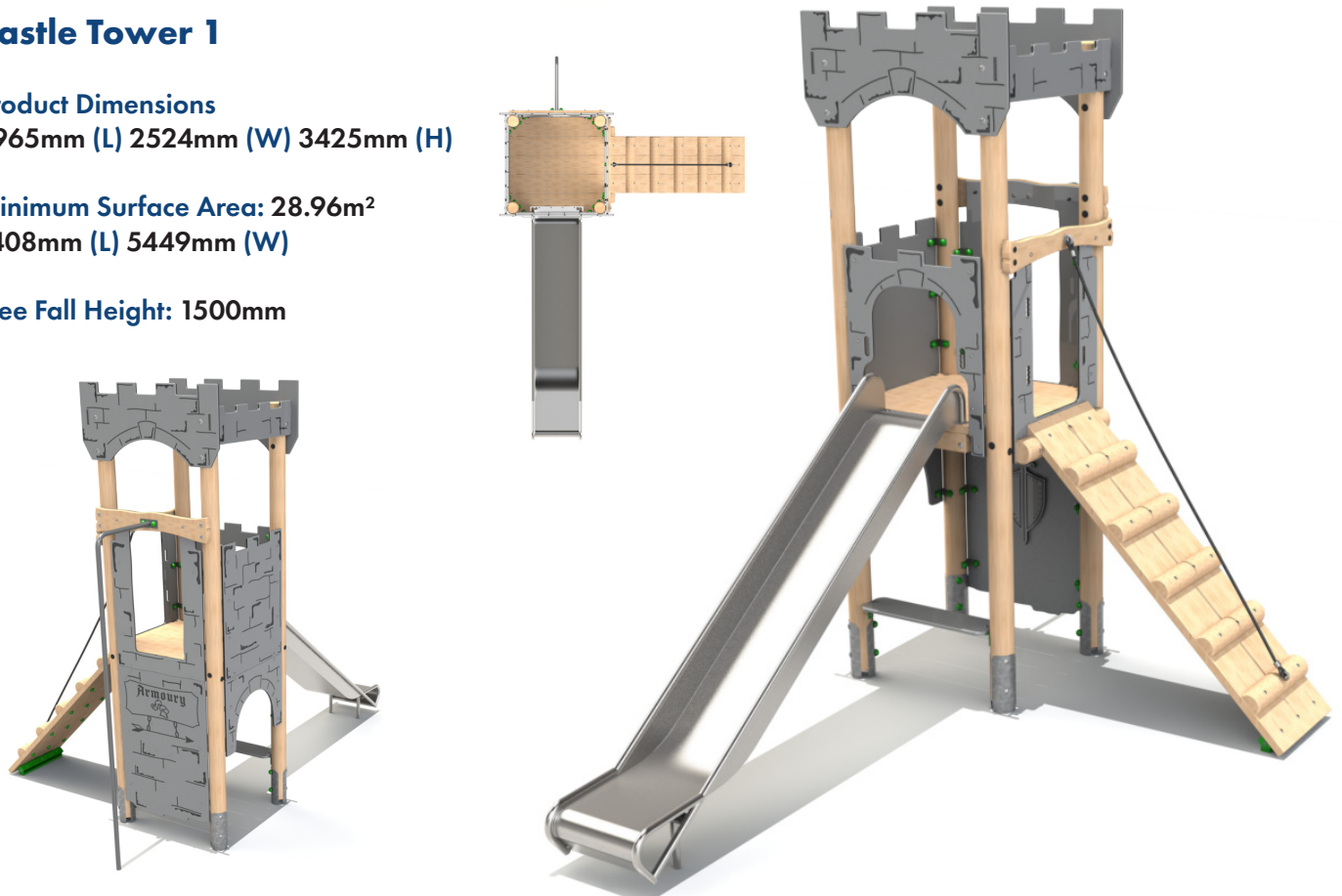

Bespoke Towers available, enquire for more information.

Castle Tower 2

Product Dimensions

4696mm (L) 2505mm (W) 3191mm (H)

Minimum Surface Area: 40.33m²

7614mm (L) 7554mm (W)

Free Fall Height: 1327mm

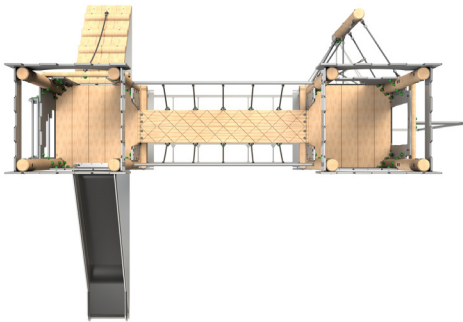
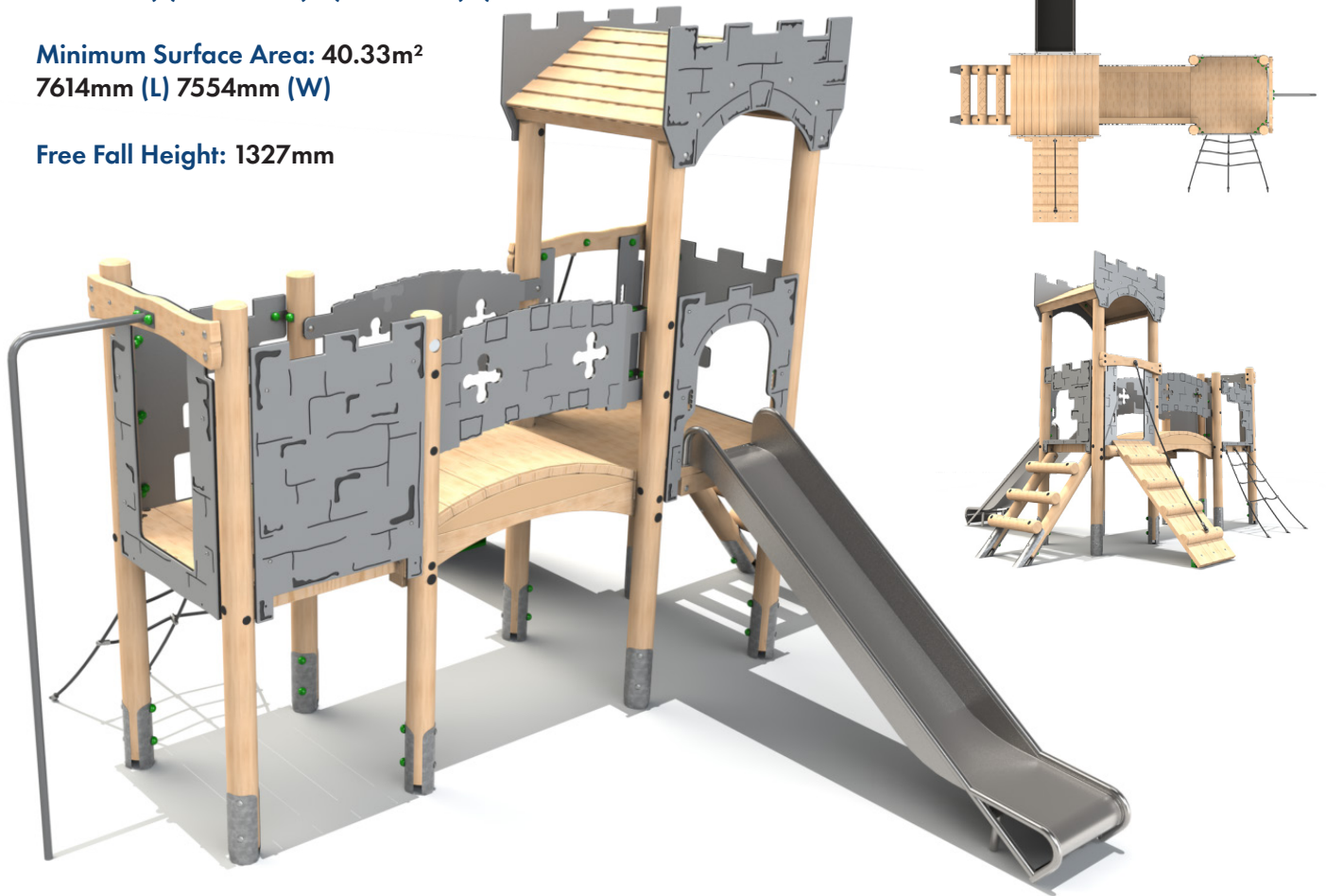

Castle Tower 3

Product Dimensions

5185mm (L) 4145mm (W) 3241mm (H)

Minimum Surface Area: 41.6m²

8169mm (L) 7614mm (W)

Free Fall Height: 1200mm

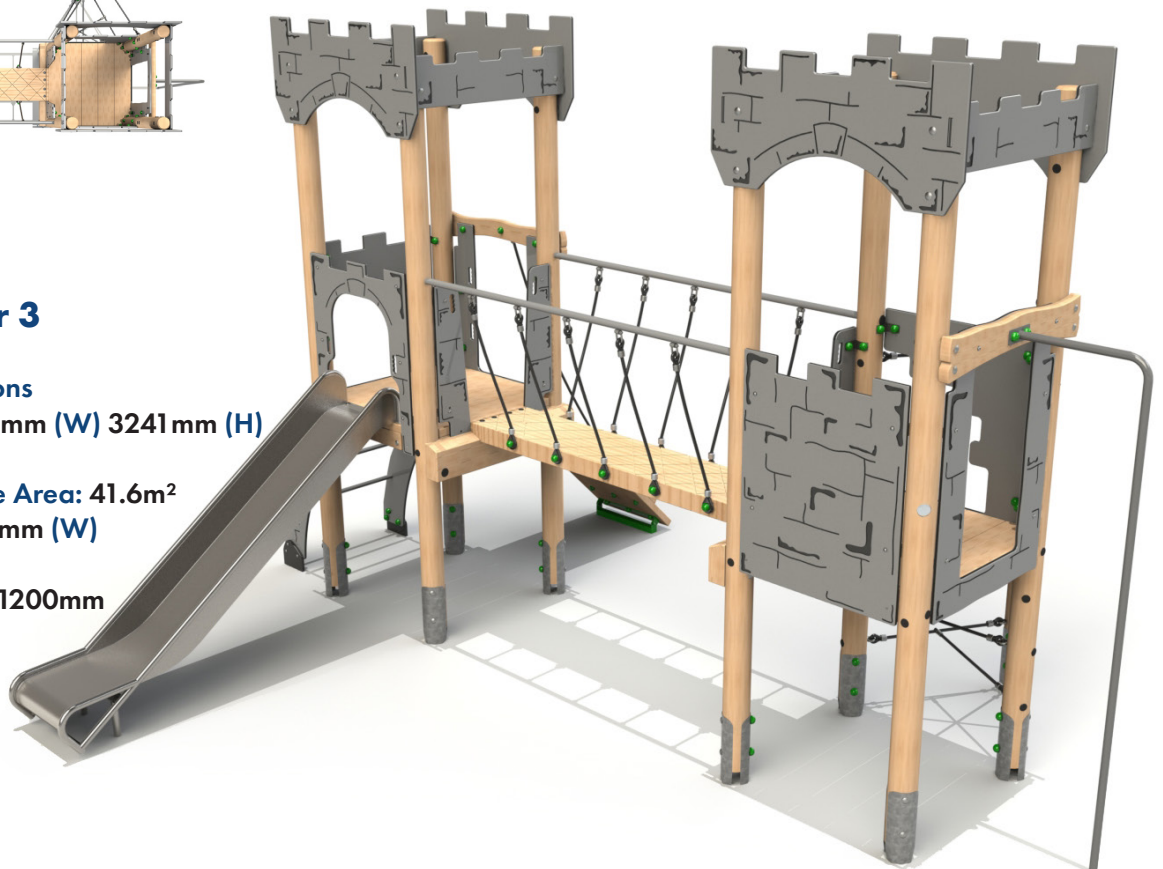

Steel feet as standard, bespoke rope colours available.

Timber Towers

Castle Tower 4

Product Dimensions

4717mm (L) 3903mm (W) 3490mm (H)

Minimum Surface Area: 41.31m²

7625mm (L) 7371mm (W)

Free Fall Height: 1500mm

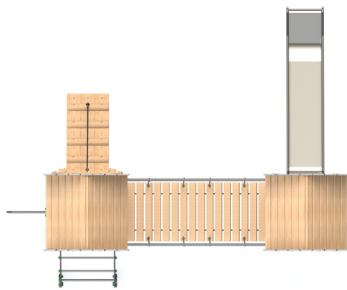

Castle Tower 5

Product Dimensions

5684mm (L) 3965mm (W) 3460mm (H)

Minimum Surface Area: 42.57m²

8693mm (L) 7417mm (W)

Free Fall Height: 1500mm

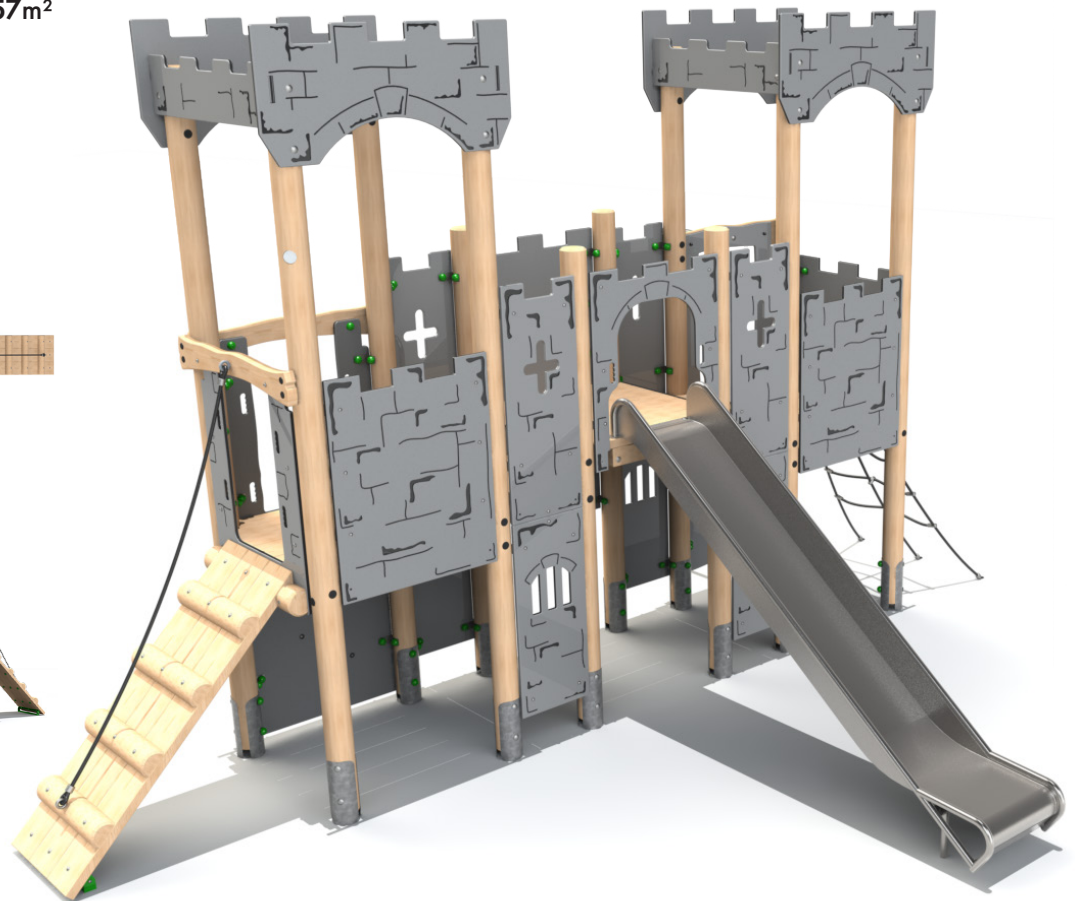
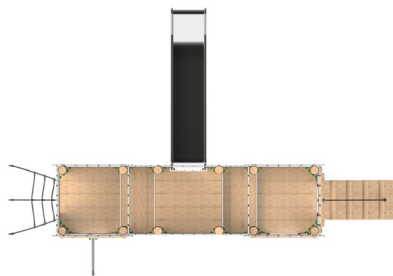

Bespoke Towers available, enquire for more information.

Timber Towers



Castle Tower 6

Product Dimensions

5242mm (L) 4603mm (W)

3491mm (H)

Minimum Surface Area: 51.32m²

8167mm (L) 7611mm (W)

Free Fall Height: 1500mm

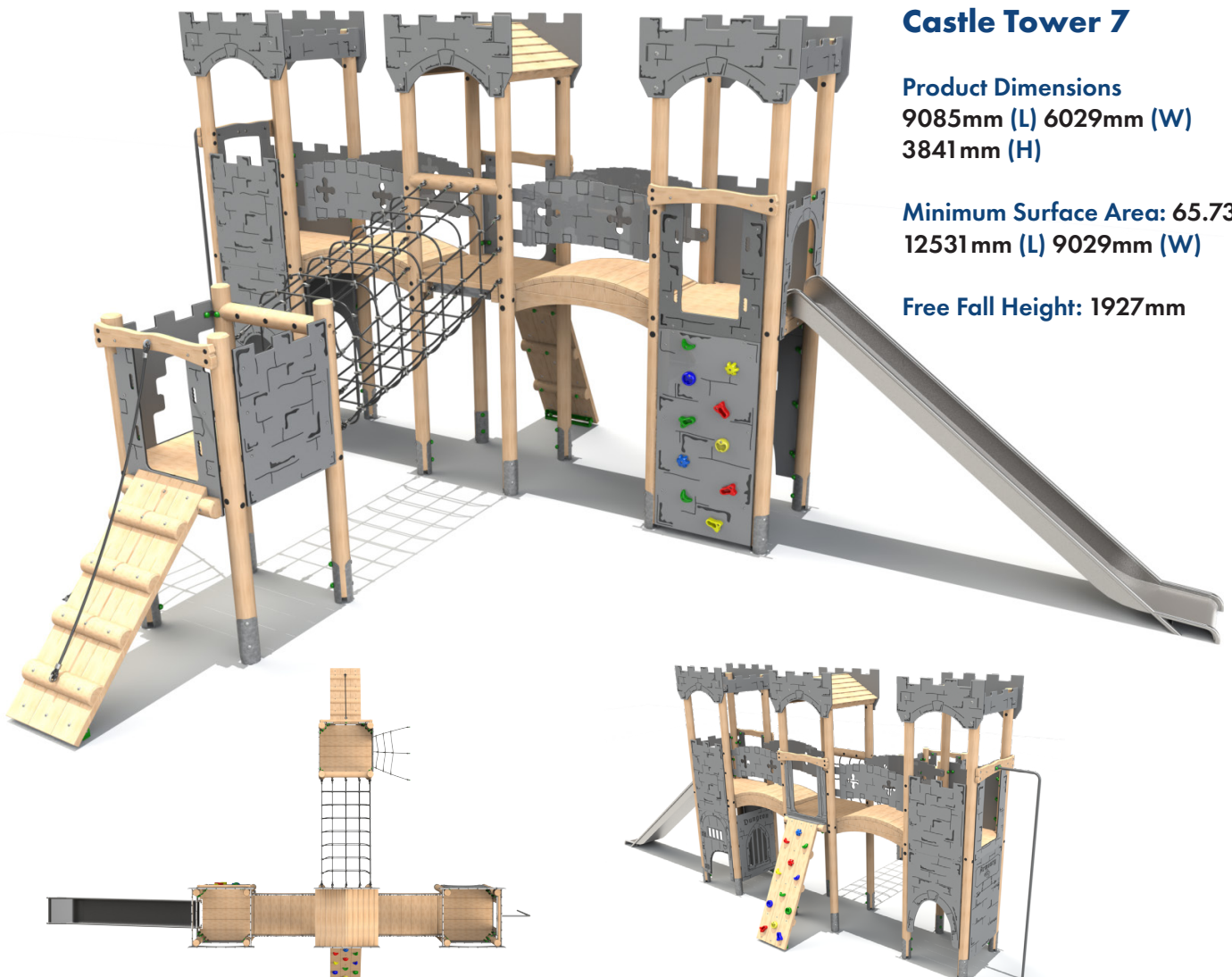

Castle Tower 7

Product Dimensions

9085mm (L) 6029mm (W)

3841mm (H)

Minimum Surface Area: 65.73m²

12531mm (L) 9029mm (W)

Free Fall Height: 1927mm

Steel feet as standard, bespoke rope colours available.

Timber Towers

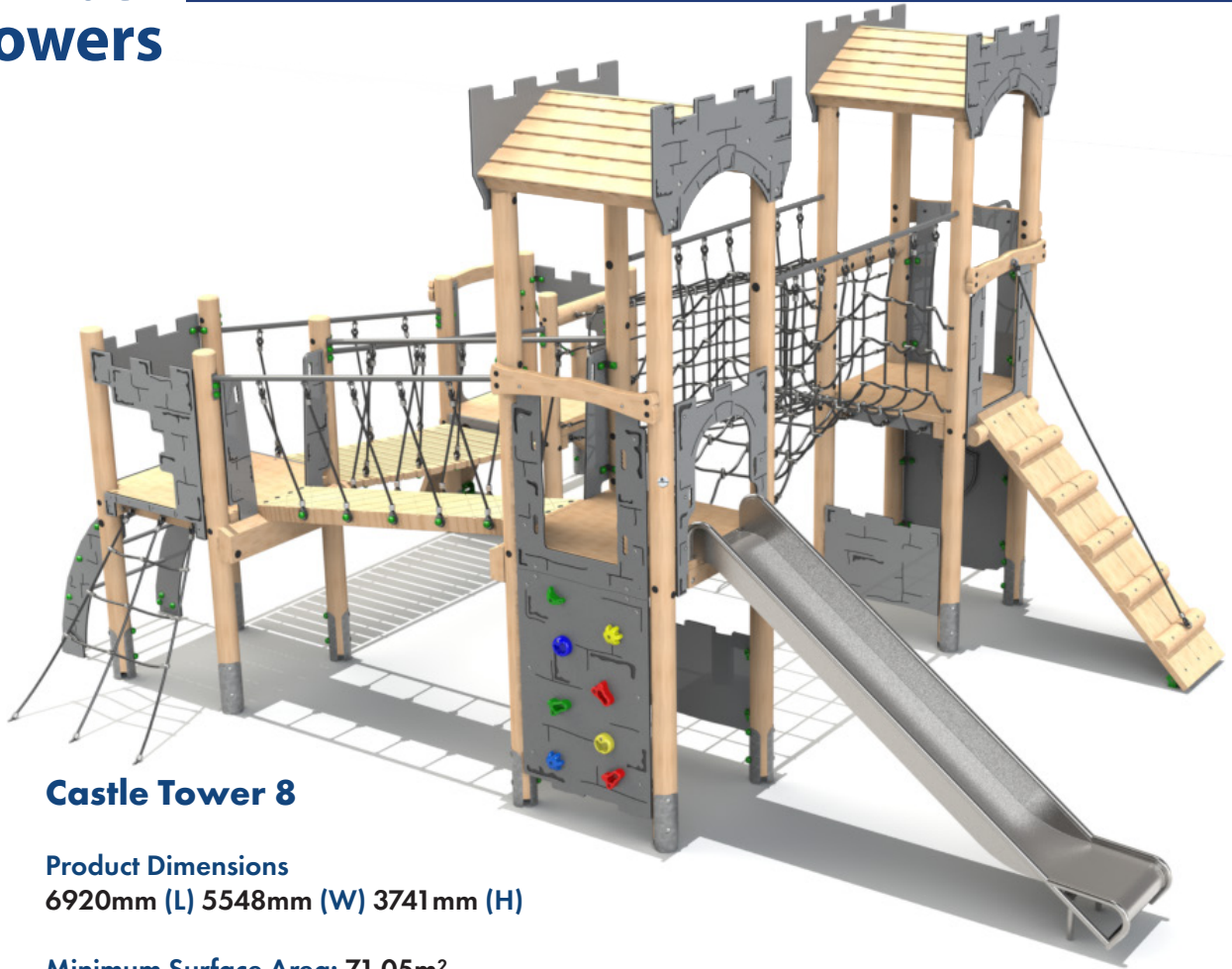

Castle Tower 8

Product Dimensions

6920mm (L) 5548mm (W) 3741mm (H)

Minimum Surface Area: 71.05m²

10390mm (L) 8556mm (W)

Free Fall Height: 1500mm

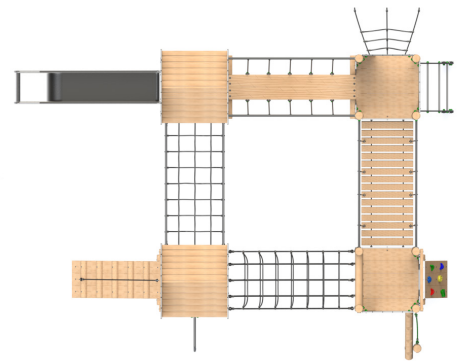

Bespoke Towers available, enquire for more information.

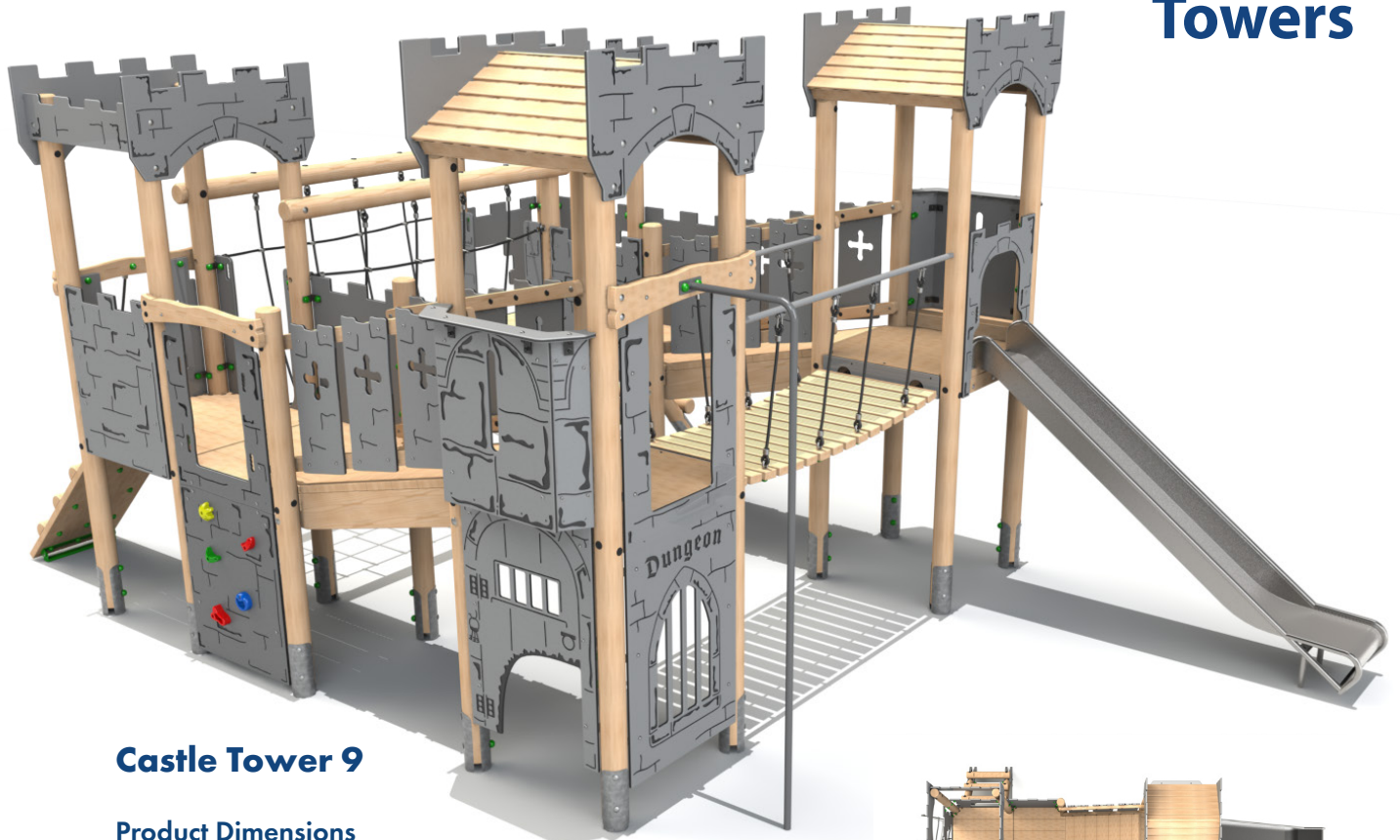

Castle Tower 9

Product Dimensions

7599mm (L) 5119mm (W) 3491 mm (H)

Minimum Surface Area: 65.84m²

10697mm (L) 8134mm (W)

Free Fall Height: 1500mm

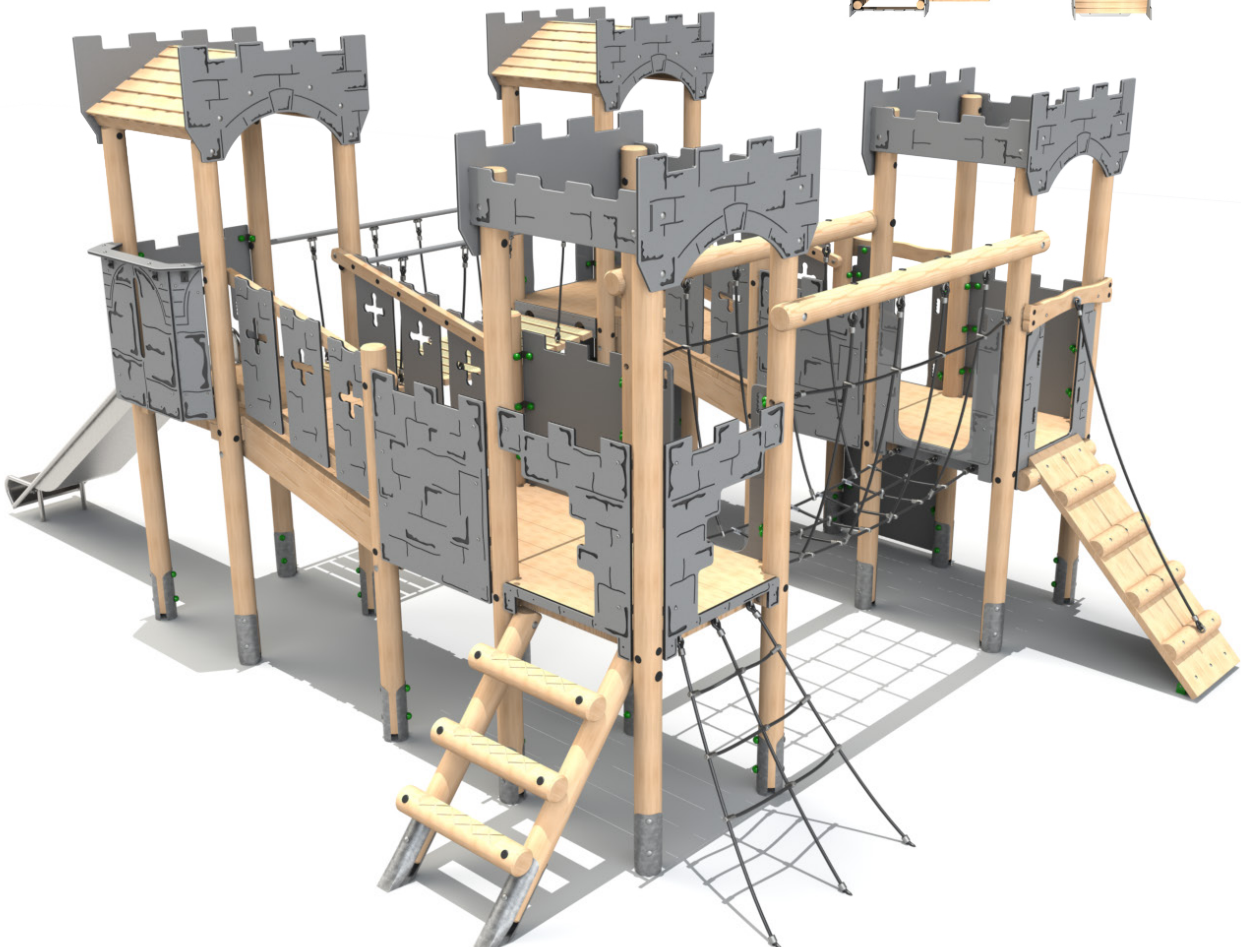
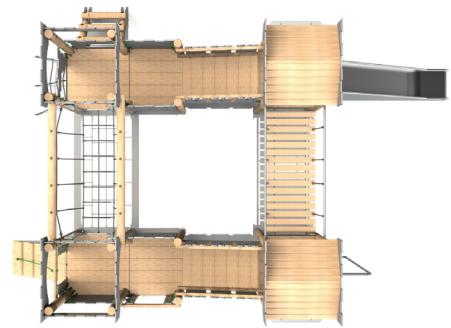

Steel feet as standard, bespoke rope colours available.

Timber Towers

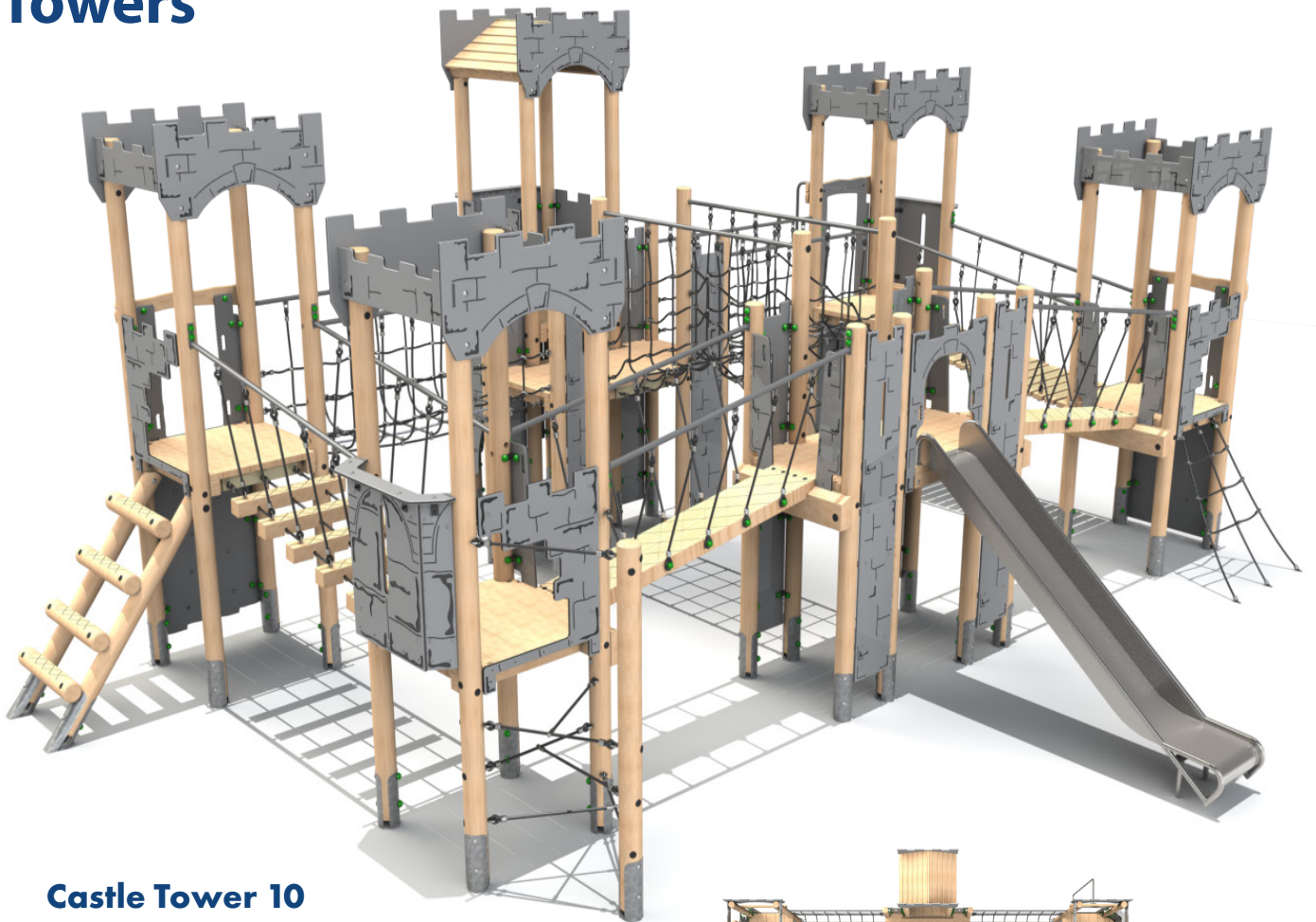

Castle Tower 10

Product Dimensions

9243mm (L) 7490mm (W) 4041mm (H)

Minimum Surface Area: 97.08m²

12251mm (L) 10929mm (W)

Free Fall Height: 1895mm

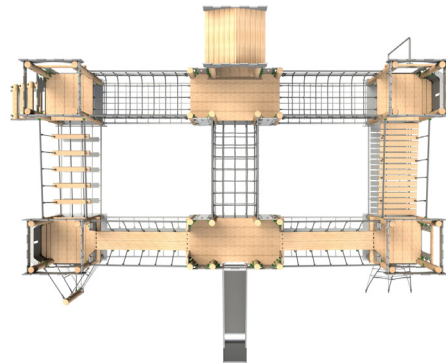

Bespoke Towers available, enquire for more information.

Clamber Tower 2

Product Dimensions

6091mm (L) 4842mm (W) 2678mm (H)

Minimum Surface Area: 54.32m²

9257mm (L) 8535mm (W)

Free Fall Height: 1500mm

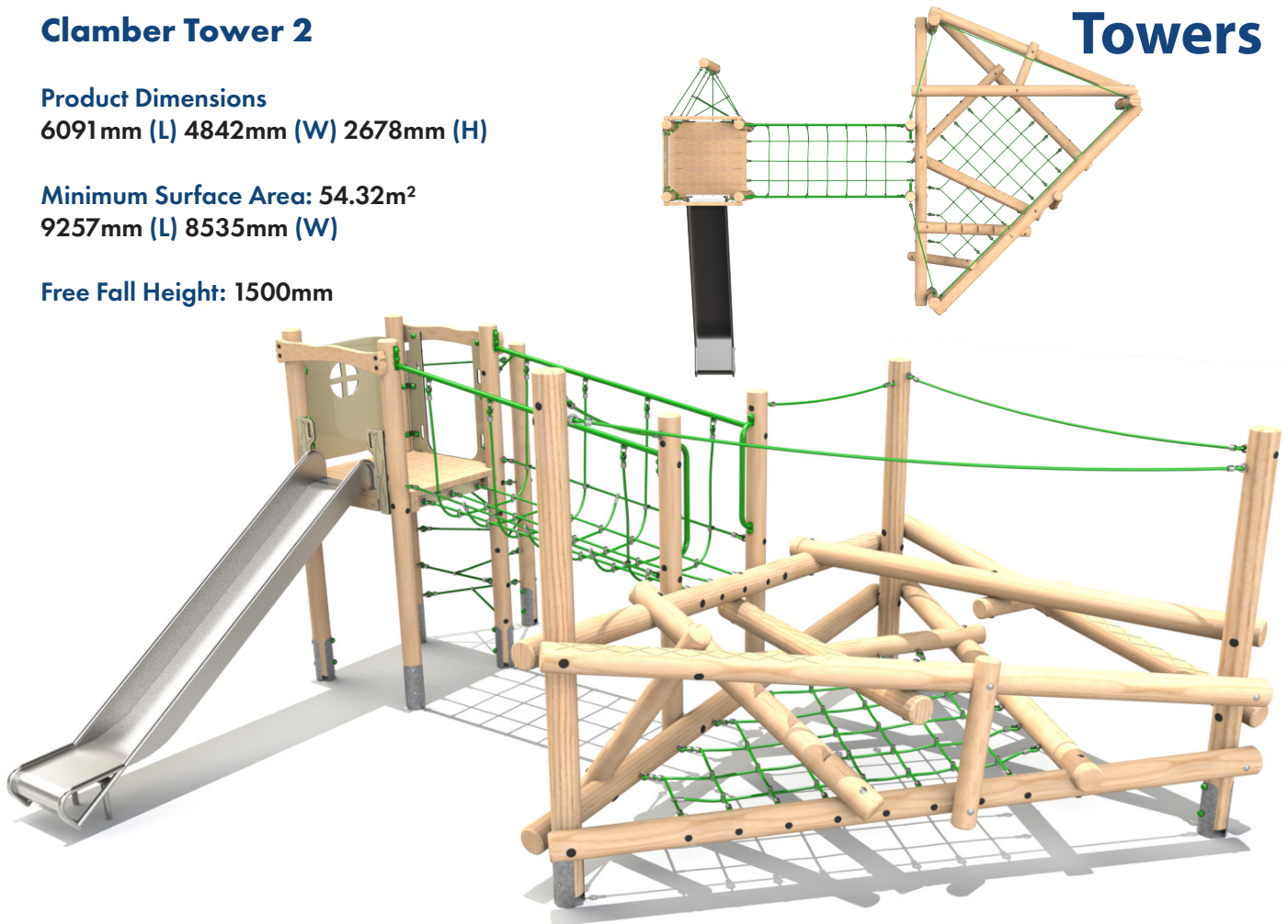

Clamber Tower 2 Castle

Product Dimensions

6636mm (L) 4842mm (W)

3535mm (H)

Minimum Surface Area: 54.54m²

9802mm (L) 8535mm (W)

Free Fall Height: 1500mm

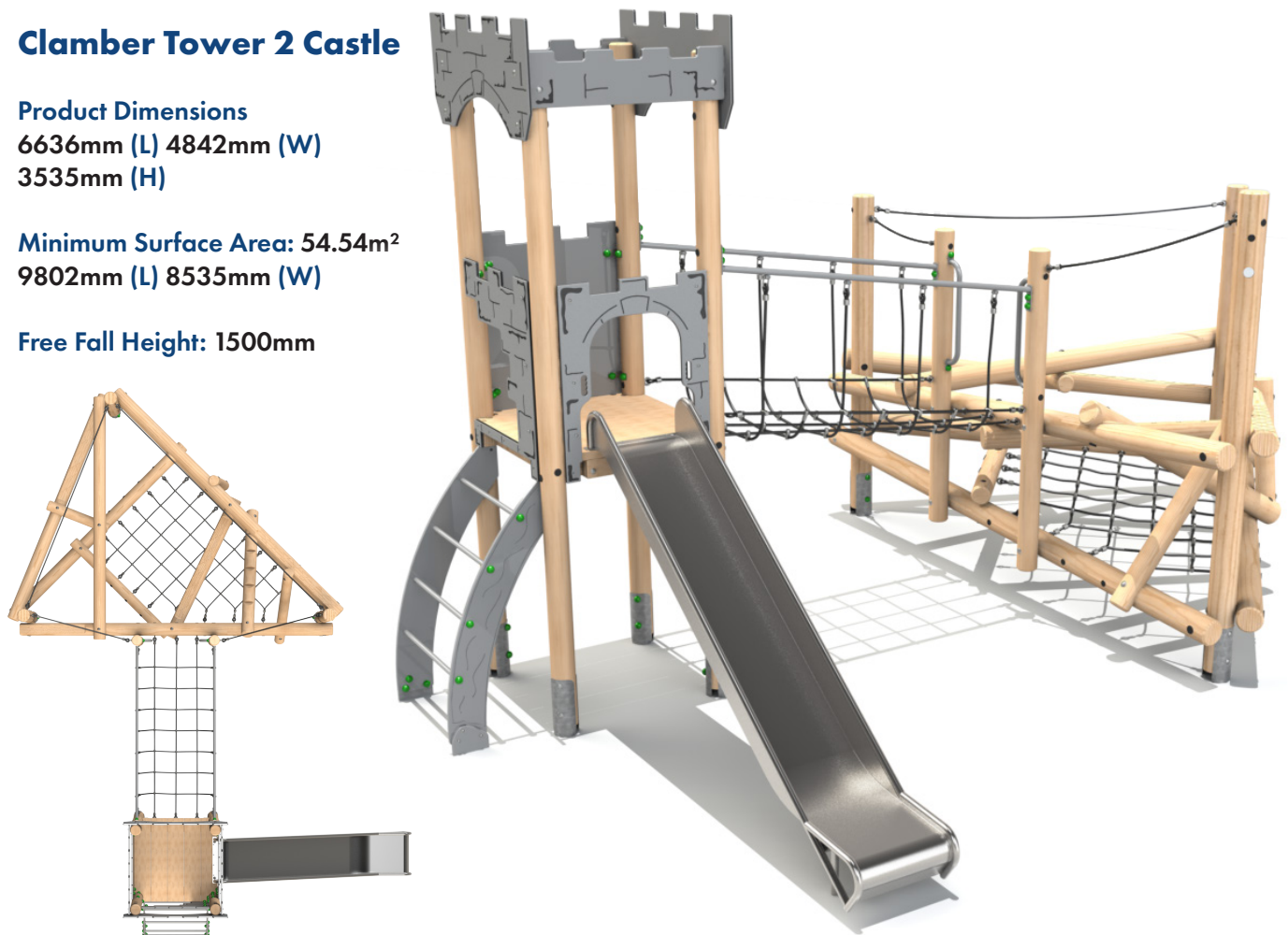

Steel feet as standard, bespoke rope colours available.

Timber Towers

Clamber Tower Mezzo

Product Dimensions
6372mm (L) 5978mm (W) 2854mm (H)

Minimum Surface Area: 63.91m²
9366mm (L) 9477mm (W)

Free Fall Height: 1500mm

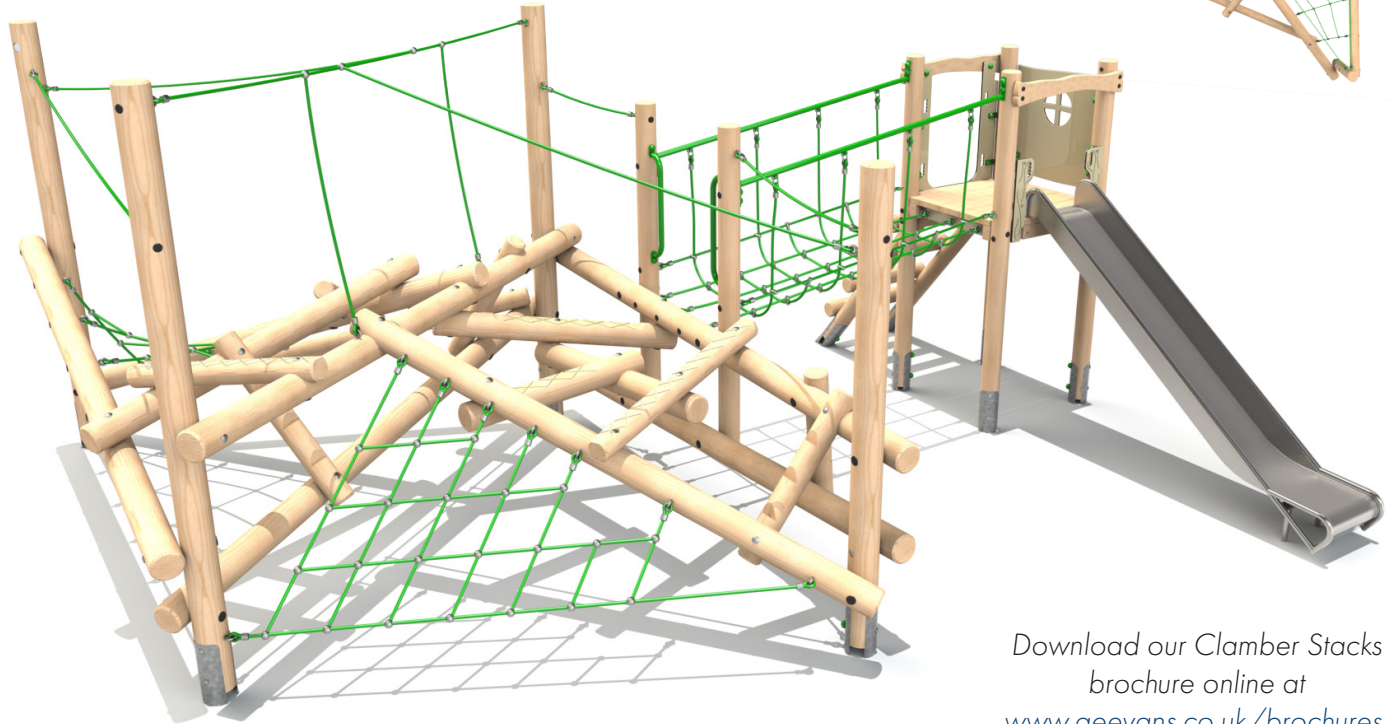

Download our Clamber Stacks brochure online at www.aeevans.co.uk/brochures.

Clamber Tower 3 Double Deck Castle

Product Dimensions
9484mm (L) 5543mm (W)
3740mm (H)

Minimum Surface Area: 78.91m²
13081mm (L) 8467mm (W)

Free Fall Height: 1500mm

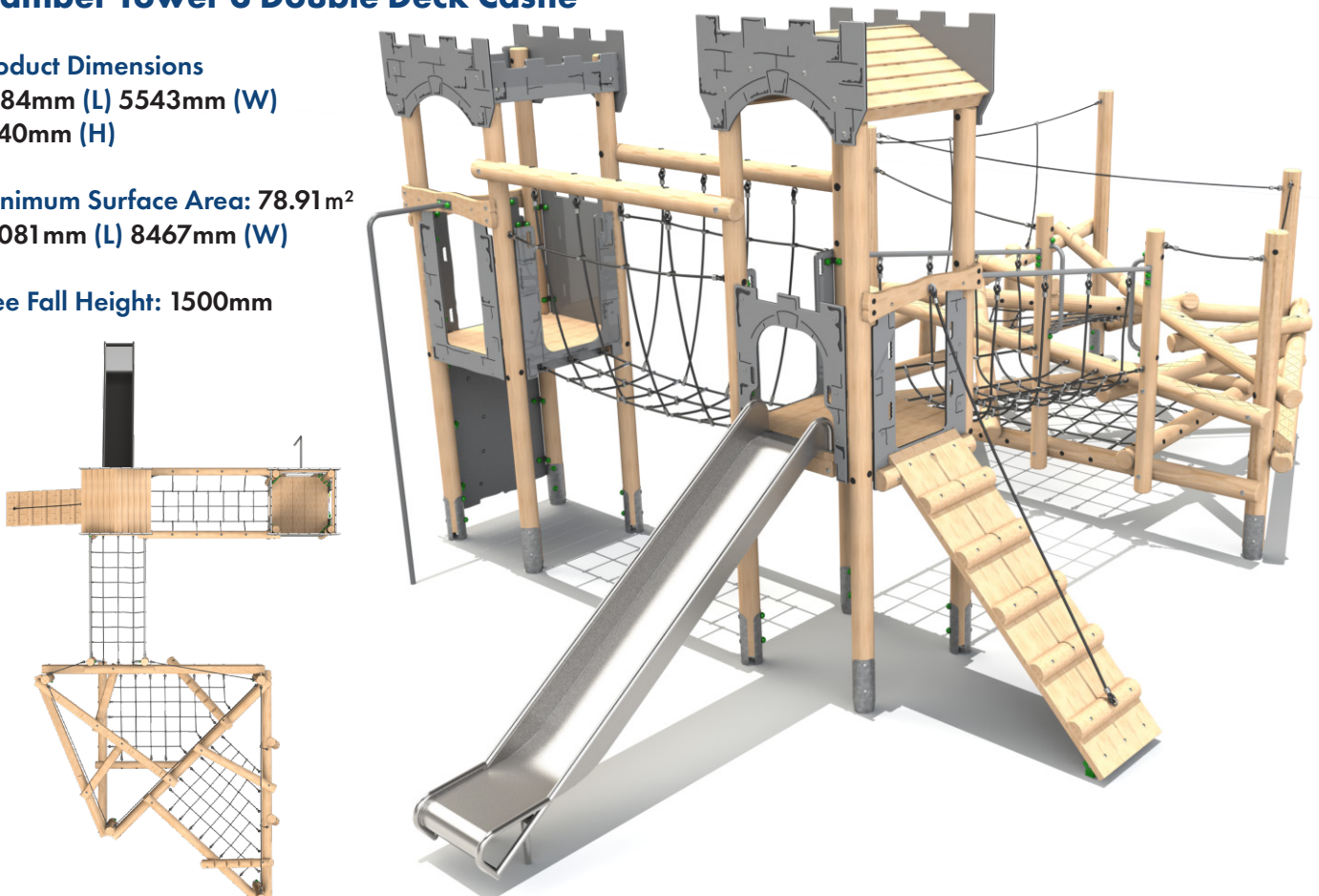

Bespoke Towers available, enquire for more information.

Clamber Tower 3

Product Dimensions

7141mm (L) 4278mm (W) 2700mm (H)

Minimum Surface Area: 63.18m²

10272mm (L) 7990mm (W)

Free Fall Height: 1500mm

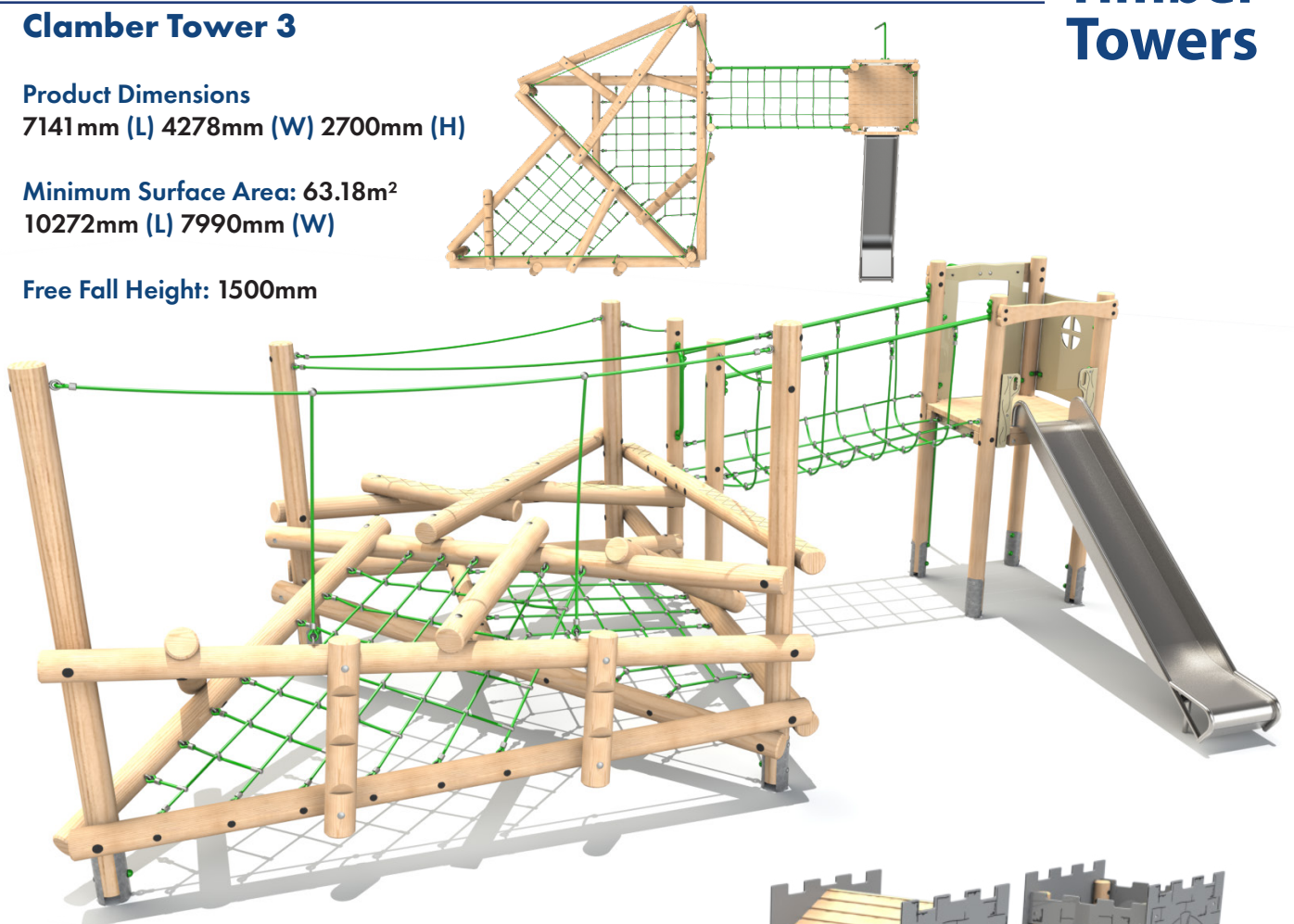

Clamber Tower 3 Triple Deck Castle

Product Dimensions

9484mm (L) 8203mm (W) 3737mm (H)

Minimum Surface Area: 91.54m²

13081mm (L) 11129mm (W)

Free Fall Height: 1500mm

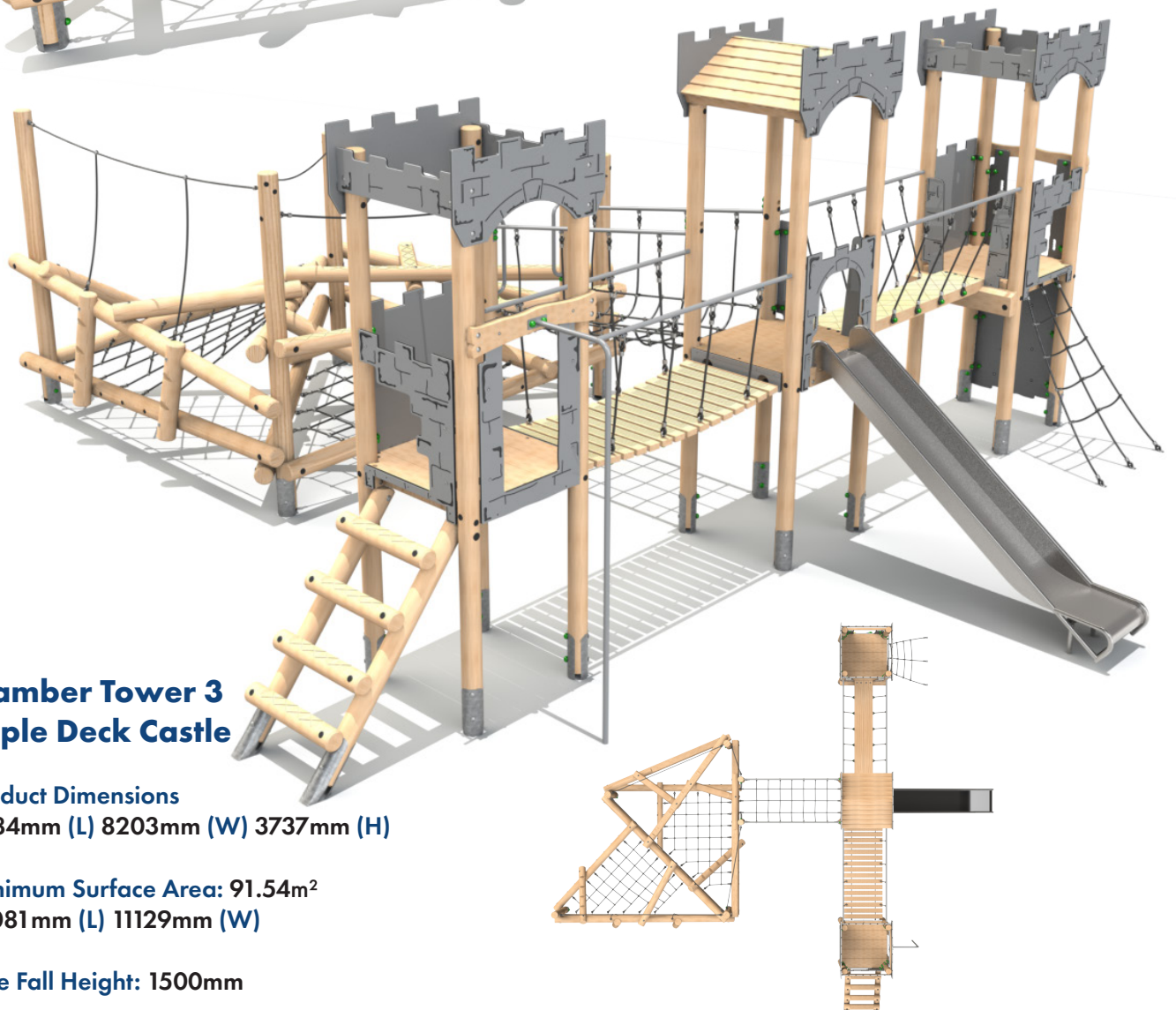

Steel feet as standard, bespoke rope colours available.

Timber Towers

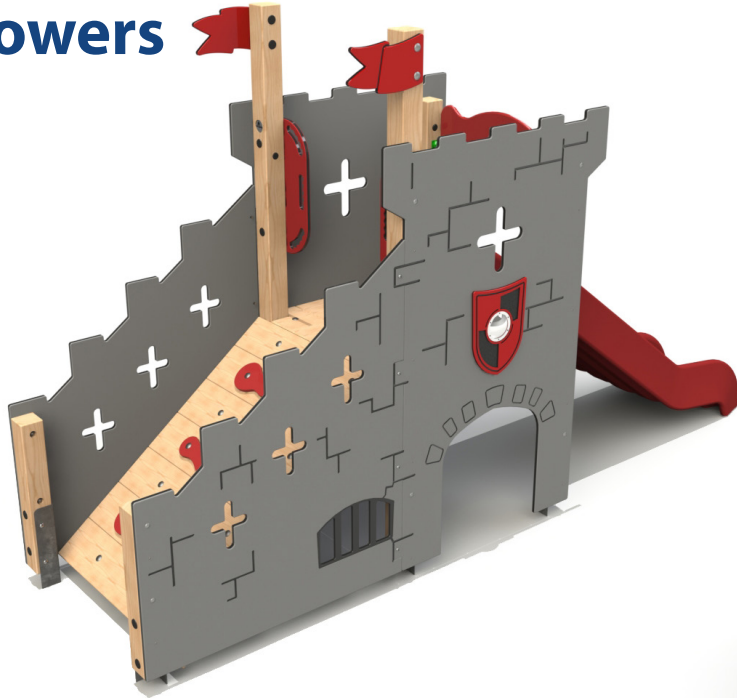

Castle Slide Unit

Product Dimensions

3830mm (L) 1090mm (W) 2270mm (H)

Minimum Surface Area: 24.5m²

7160mm (L) 3990mm (W)

Free Fall Height: 900mm

Boat Slide Unit

Product Dimensions

3830mm (L) 1120mm (W) 2170mm (H)

Minimum Surface Area: 24.5m²

7160mm (L) 3990mm (W)

Free Fall Height: 900mm



Dump Truck Slide Unit

Product Dimensions

4040mm (L) 1060mm (W) 1810mm (H)

Minimum Surface Area: 24.5m²

7160mm (L) 3990mm (W)

Free Fall Height: 900mm



Elephant Slide Unit

Product Dimensions

4040mm (L) 1070mm (W)

1730mm (H)

Minimum Surface Area: 24.5m²

7160mm (L) 3990mm (W)

Free Fall Height: 900mm

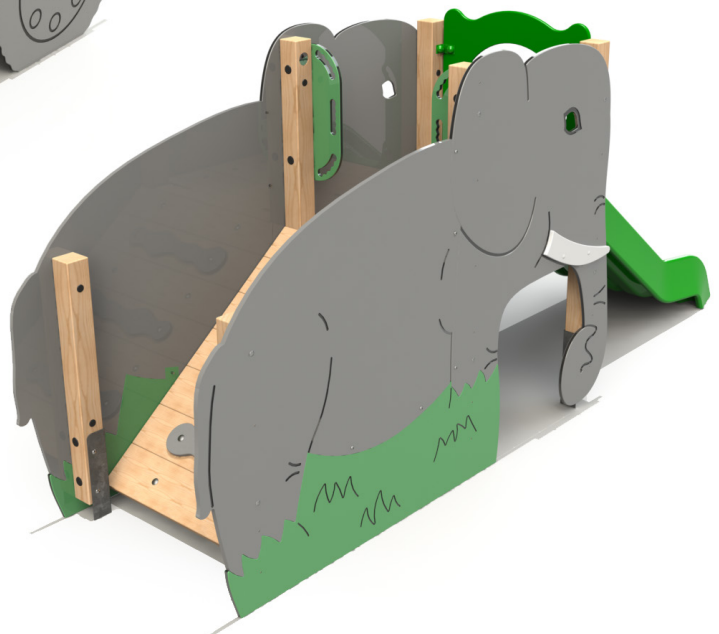

Bespoke Towers available, enquire for more information.

Timber Towers

Fire Engine Slide Unit



Product Dimensions

3880mm (L) 1070mm (W) 1810mm (H)

Minimum Surface Area: 24.5m²

7160mm (L) 3990mm (W)

Free Fall Height: 900mm

Rocket Slide Unit

Product Dimensions

3840mm (L) 1180mm (W) 2460mm (H)

Minimum Surface Area: 24.5m²

7160mm (L) 3990mm (W)

Free Fall Height: 900mm

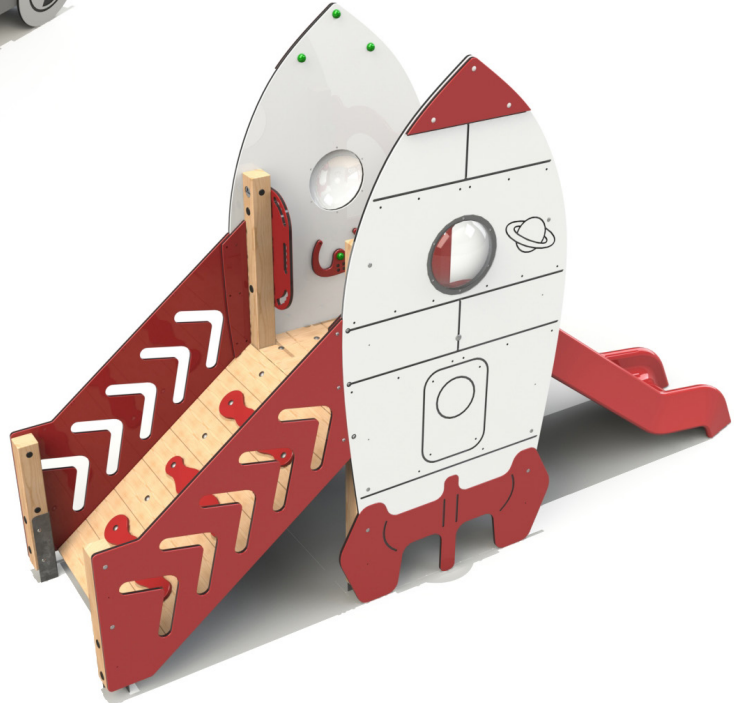

Submarine Slide Unit

Product Dimensions

4040mm (L) 1170mm (W) 2310mm (H)

Minimum Surface Area: 24.5m²

7160mm (L) 3990mm (W)

Free Fall Height: 900mm

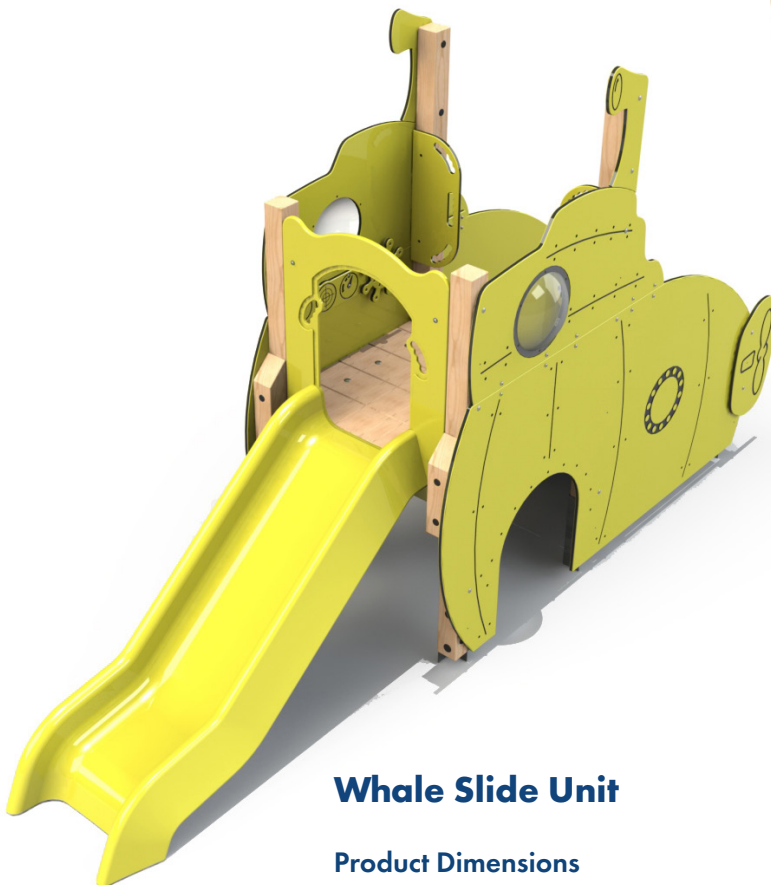

Whale Slide Unit

Product Dimensions

3970mm (L) 1180mm (W) 2270mm (H)

Minimum Surface Area: 24.5m²

7160mm (L) 3990mm (W)

Free Fall Height: 900mm



Steel feet as standard, bespoke rope colours available.



The ability to offer unrivalled value for money whilst still ensuring exceptional quality and longevity is key. The Timber Towers range accommodates all ages, budgets and play scheme sizes.

Our uncompromising approach to safety during the design and manufacturing process is paramount. With this in mind all the Timber Towers range are designed to meet the requirements of BS EN 1176.

Choose from either standard towers or create a bespoke design using the interchangeable modular play elements.

In order to ensure the highest level of accuracy, all units are produced on a custom made, state of the art, 6 Axis CNC machine. This technology allows us to offer unparalleled accuracy in the field of play timber production.

Tel: 07929344505

Email: alex@rsjplay.co.uk

www.rsjplay.co.uk

RSJ Play Ltd, 3 Boscobel Road, Walsall, West Midlands, WS1 2PL