

play in
motion

RSTJ PLAY



2.0m - 1 Cradle Seat

L: 2610 W: 1424 H: 2138mm
 Min Surface Area: 6.05 x 1.75m (10.6m²)
 Min Space: 6.05 x 2.61m FFH: 1.2m

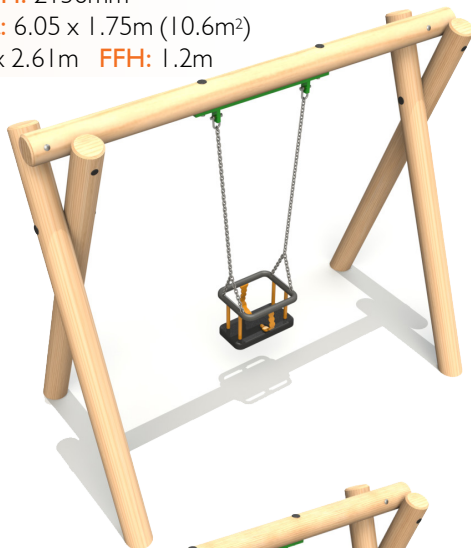

2.4m - 1 Flat Seat

L: 2610 W: 1730 H: 2538mm
 Min Surface Area: 6.7 x 1.75m (11.7m²)
 Min Space: 6.7 x 2.61m FFH: 1.4m

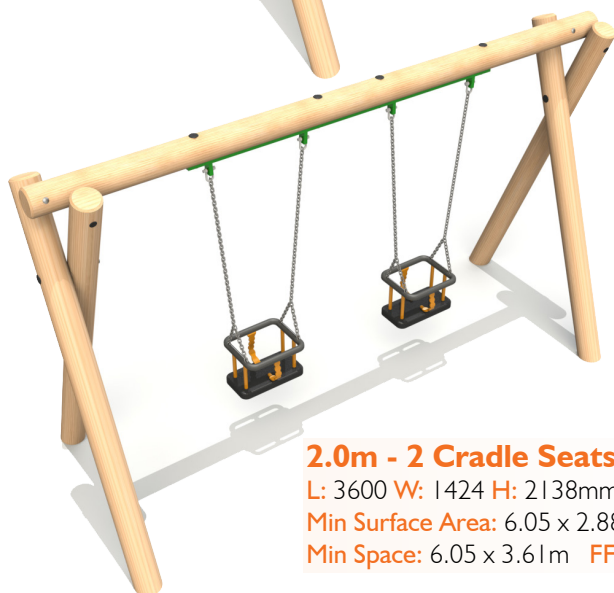

2.0m - 2 Cradle Seats

L: 3600 W: 1424 H: 2138mm
 Min Surface Area: 6.05 x 2.88m (17.4m²)
 Min Space: 6.05 x 3.61m FFH: 1.2m



2.4m - 2 Flat Seats

L: 3600 W: 1730 H: 2538mm
 Min Surface Area: 6.7 x 2.88m (19.3m²)
 Min Space: 6.7 x 3.61m FFH: 1.4m

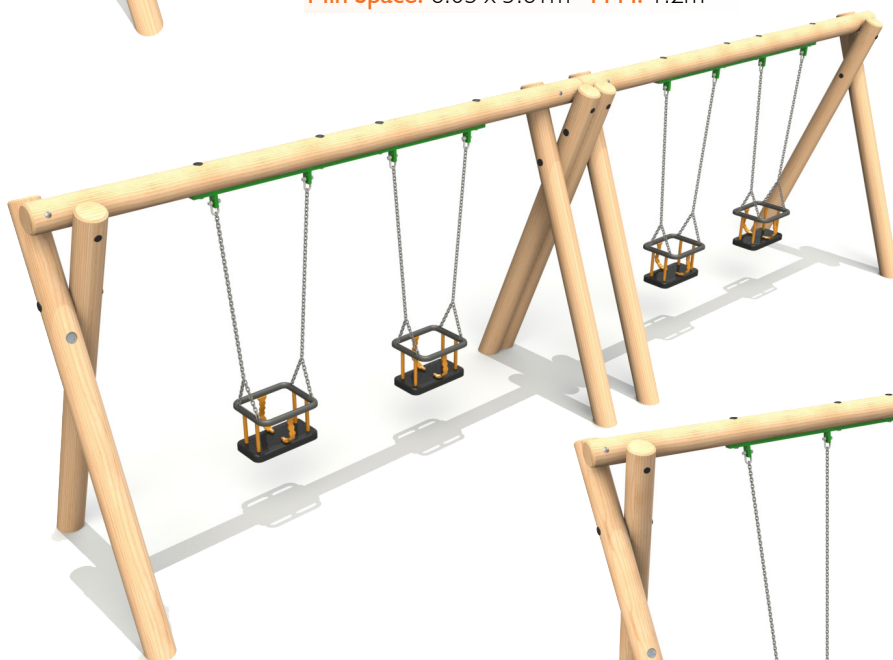

2.0m - 4 Cradle Seats

L: 7200 W: 1424 H: 2138mm
 Min Surface Area: 6.05 x 5.76m (34.8m²)
 Min Space: 7.2 x 6.05m FFH: 1.2m

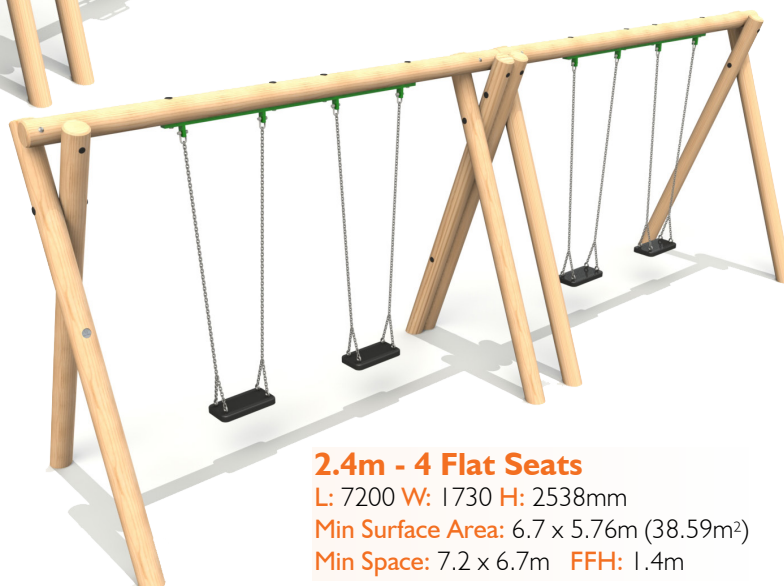

2.4m - 4 Flat Seats

L: 7200 W: 1730 H: 2538mm
 Min Surface Area: 6.7 x 5.76m (38.59m²)
 Min Space: 7.2 x 6.7m FFH: 1.4m

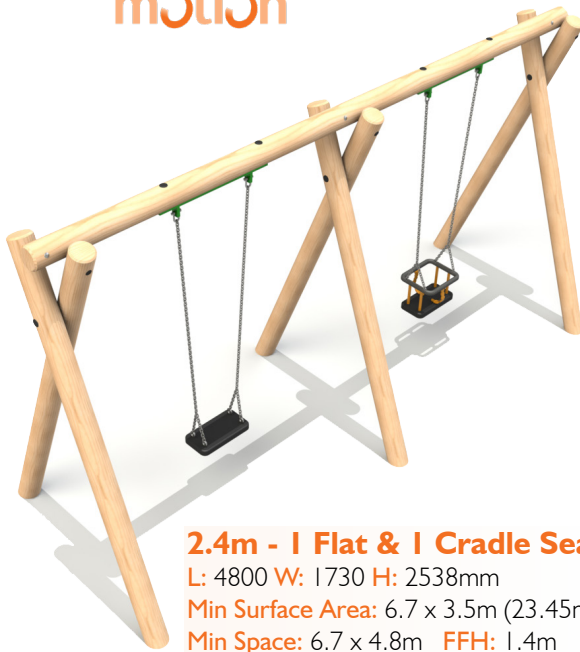

2.4m - 2 Flat & 1 Cradle Seats
 L: 6210 W: 1730 H: 2538mm
 Min Surface Area: 6.7 x 4.63m (31.02m²)
 Min Space: 6.7 x 6.2m FFH: 1.4m

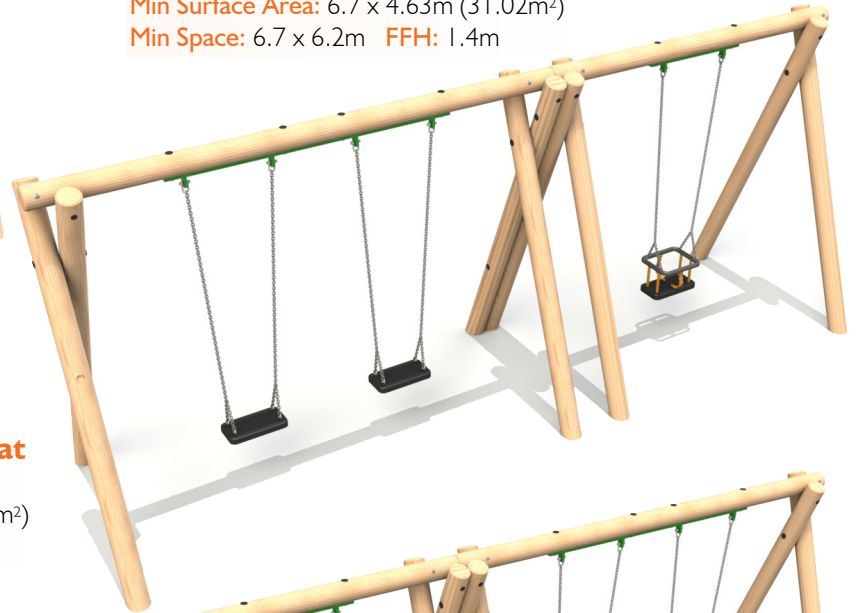

2.4m - 1 Flat & 1 Cradle Seat
 L: 4800 W: 1730 H: 2538mm
 Min Surface Area: 6.7 x 3.5m (23.45m²)
 Min Space: 6.7 x 4.8m FFH: 1.4m



2.4m - 1 Inclusive Seat
 L: 2742 W: 1730 H: 2538mm
 Min Surface Area: 7 x 1.8m (12.6m²)
 Min Space: 7 x 2.61m FFH: 1.4m

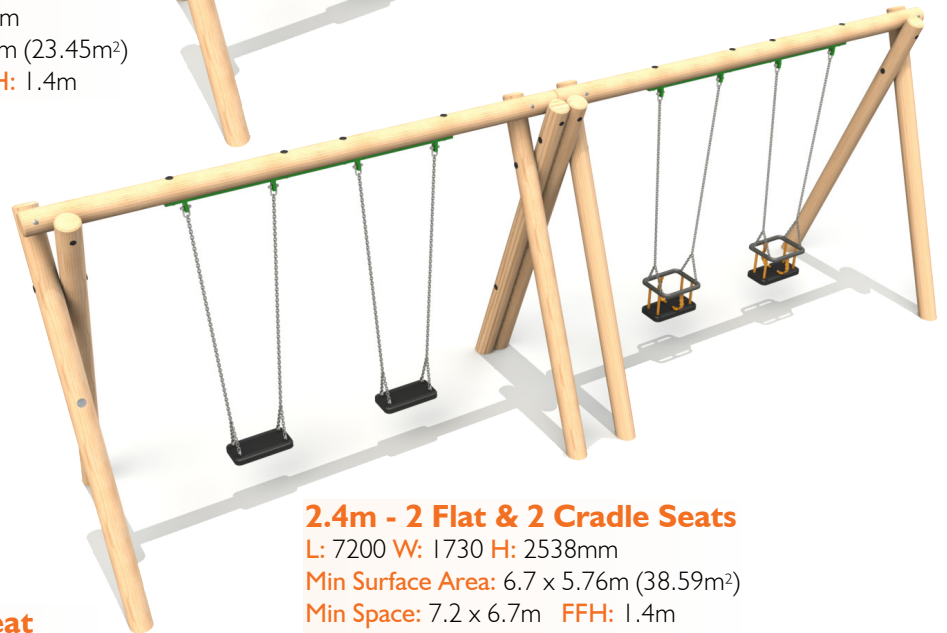

2.4m - 2 Flat & 2 Cradle Seats
 L: 7200 W: 1730 H: 2538mm
 Min Surface Area: 6.7 x 5.76m (38.59m²)
 Min Space: 7.2 x 6.7m FFH: 1.4m



2.4m - 1 Inclusive & 1 Cradle Seat
 L: 3600 W: 1730 H: 2538mm
 Min Surface Area: 7 x 2.93m (20.51m²)
 Min Space: 7 x 3.61m FFH: 1.4m



2.4m - 1 Inclusive & 1 Flat Seat
 L: 3600 W: 1730 H: 2538mm
 Min Surface Area: 7 x 2.93m (20.51m²)
 Min Space: 7 x 3.61m FFH: 1.4m



Steel feet

Galvanised steel feet can be fitted on all timber swings for a small additional charge. Steel feet offer an alternative to in-ground timbers and can be used in both wet pour and extended for loose fill surfacing.



2.4m Timber Group Swing

L: 3600 W: 1730 H: 2538mm
 Min Surface Area: 7 x 3m (21m²)
 Min Space: 7 x 3.61m FFH: 1.4m



2.4m - 1 Flat & 1 Group Seat

L: 6210 W: 1730 H: 2538mm
 Min Surface Area: 7 x 5m (35m²)
 Min Space: 6.22 x 7m FFH: 1.4m

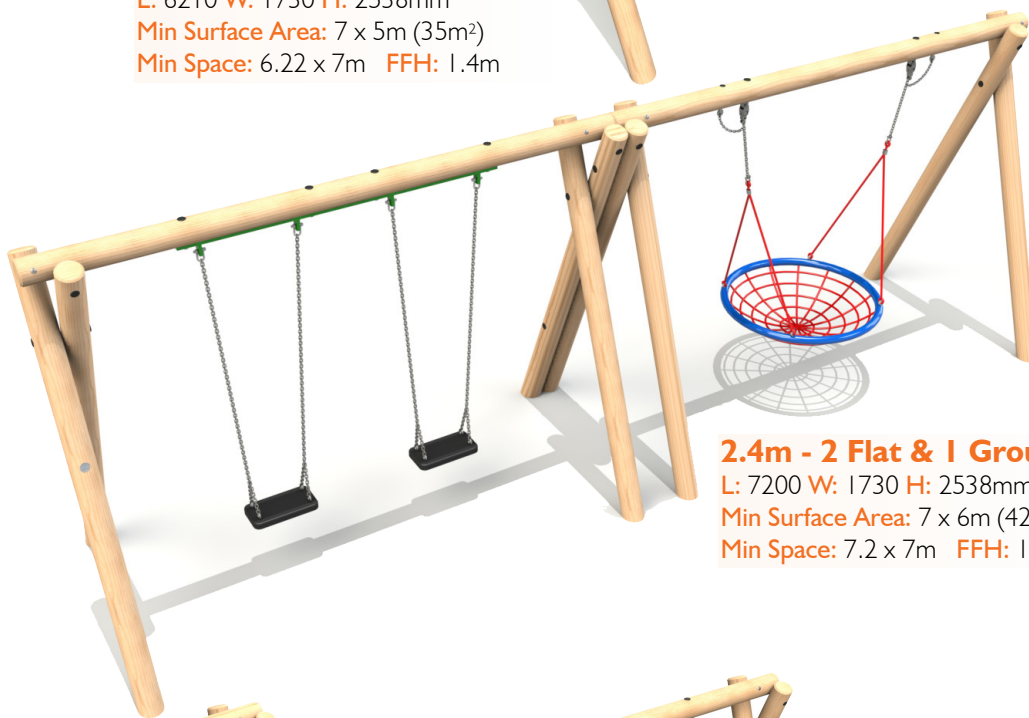

2.4m - 2 Flat & 1 Group Seat

L: 7200 W: 1730 H: 2538mm
 Min Surface Area: 7 x 6m (42m²)
 Min Space: 7.2 x 7m FFH: 1.4m



Timber Swing Frames available without seats and chains.

Frames come with all fixings and swing seat hangers. Universal joints and safety chains are not included with the group seat frames.

Six Seat Hexagonal Swing

L: 7040 W: 6139 H: 2620mm
 Min Surface Area: 12.6 x 11.8m (58.3m²)
 Min Space: 13.12 x 12.24m FFH: 1.4m



2.35m Crocodile Swing

L: 3000 W: 2800 H: 2820mm
 Min Surface Area: 8.53 x 3.2m (25.2m²)
 Min Space: 8.53 x 3.15m FFH: 1.5m
 Includes steel feet as standard

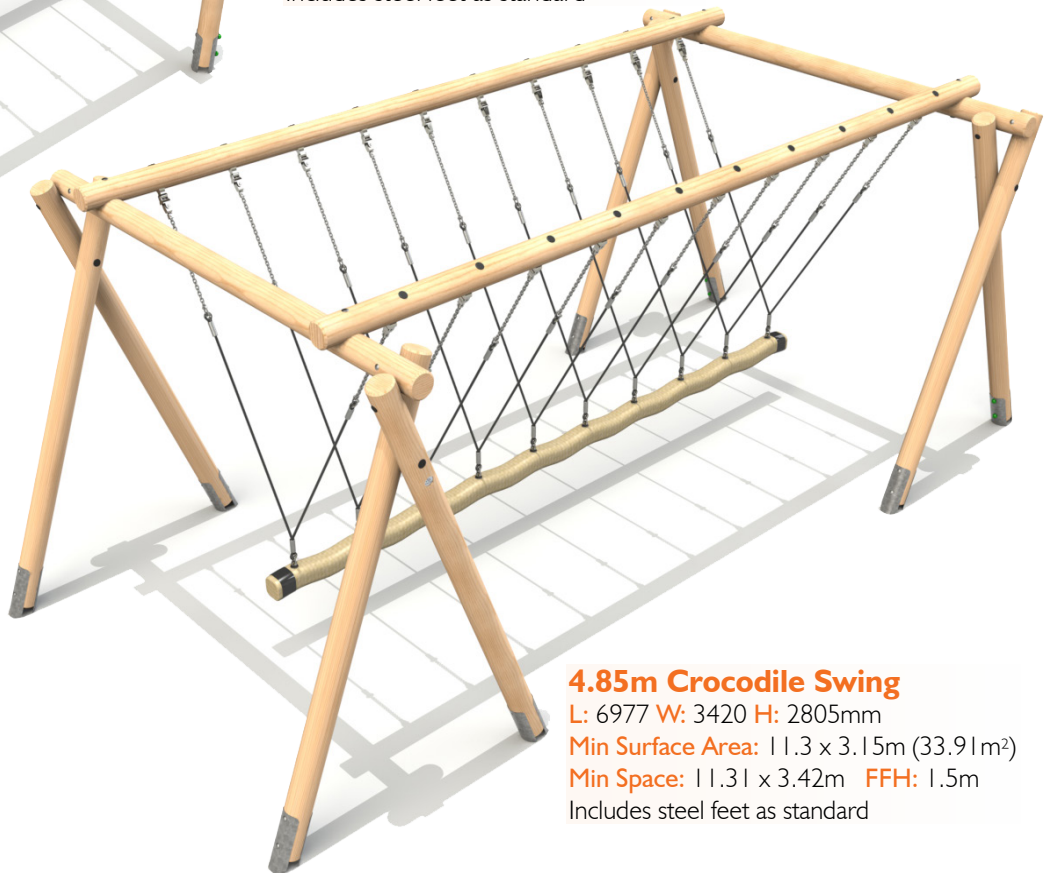

3.35m Crocodile Swing
 also available

4.85m Crocodile Swing

L: 6977 W: 3420 H: 2805mm
 Min Surface Area: 11.3 x 3.15m (33.91m²)
 Min Space: 11.31 x 3.42m FFH: 1.5m
 Includes steel feet as standard



Steel feet

Galvanised steel feet can be fitted on all timber swings for a small additional charge. Steel feet offer an alternative to in-ground timbers and can be used in both wet pour and extended for loose fill surfacing.

2.0m - 1 Cradle Seat

L: 2660 W: 1150 H: 2110mm

Min Surface Area: 6.05 x 1.75m (10.6m²)

Min Space: 6.05 x 2.66m FFH: 1.2m



2.4m - 1 Flat Seat

L: 2820 W: 1300 H: 2510mm

Min Surface Area: 6.7 x 1.75m (11.72m²)

Min Space: 6.7 x 2.82m FFH: 1.4m

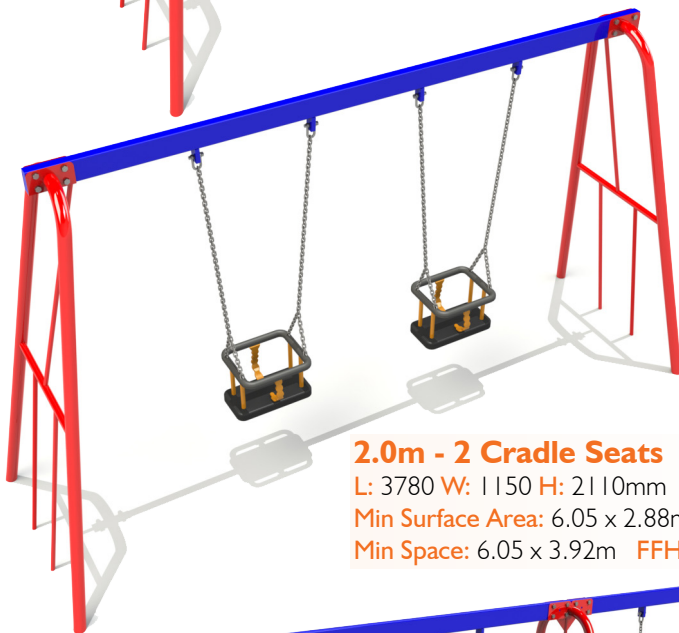

2.0m - 2 Cradle Seats

L: 3780 W: 1150 H: 2110mm

Min Surface Area: 6.05 x 2.88m (17.4m²)

Min Space: 6.05 x 3.92m FFH: 1.2m



2.4m - 2 Flat Seats

L: 3990 W: 1300 H: 2510mm

Min Surface Area: 6.7 x 2.88m (19.3m²)

Min Space: 6.7 x 3.99m FFH: 1.4m

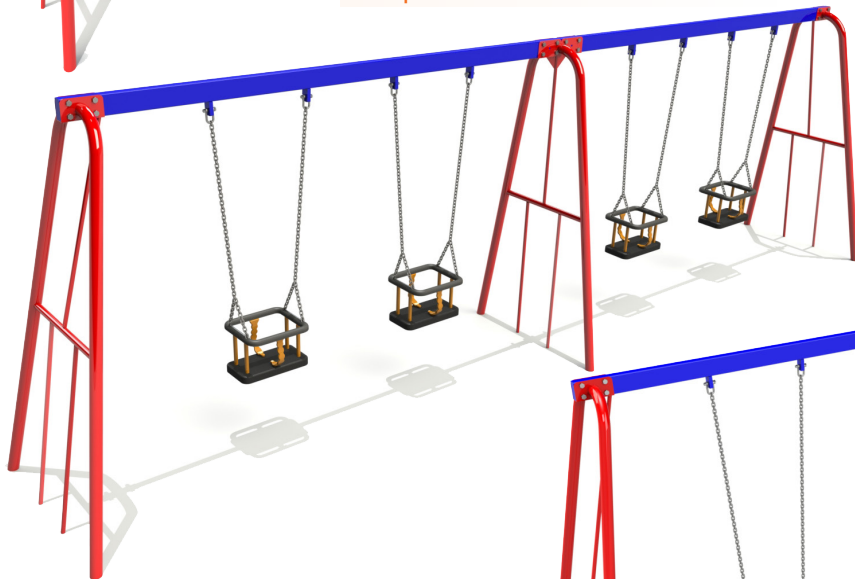

2.0m - 4 Cradle Seats

L: 6980 W: 1150 H: 2110mm

Min Surface Area: 6.05 x 5.76m (34.8m²)

Min Space: 6.98 x 6.05m FFH: 1.2m

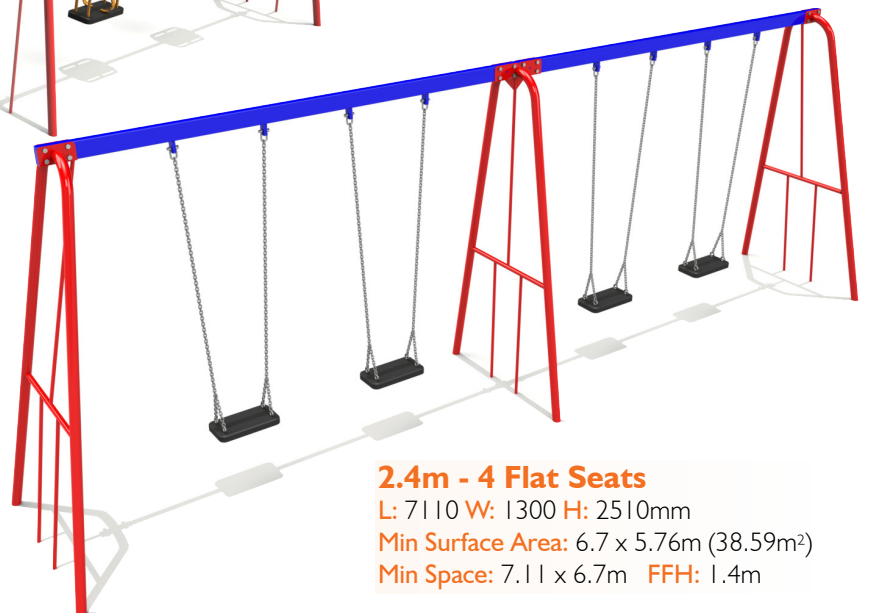

2.4m - 4 Flat Seats

L: 7110 W: 1300 H: 2510mm

Min Surface Area: 6.7 x 5.76m (38.59m²)

Min Space: 7.11 x 6.7m FFH: 1.4m



2.4m - 1 Flat & 1 Cradle Seat

L: 4880 W: 1300 H: 2510mm
 Min Surface Area: 6.7 x 3.5m (23.45m²)
 Min Space: 6.7 x 4.87m FFH: 1.4m

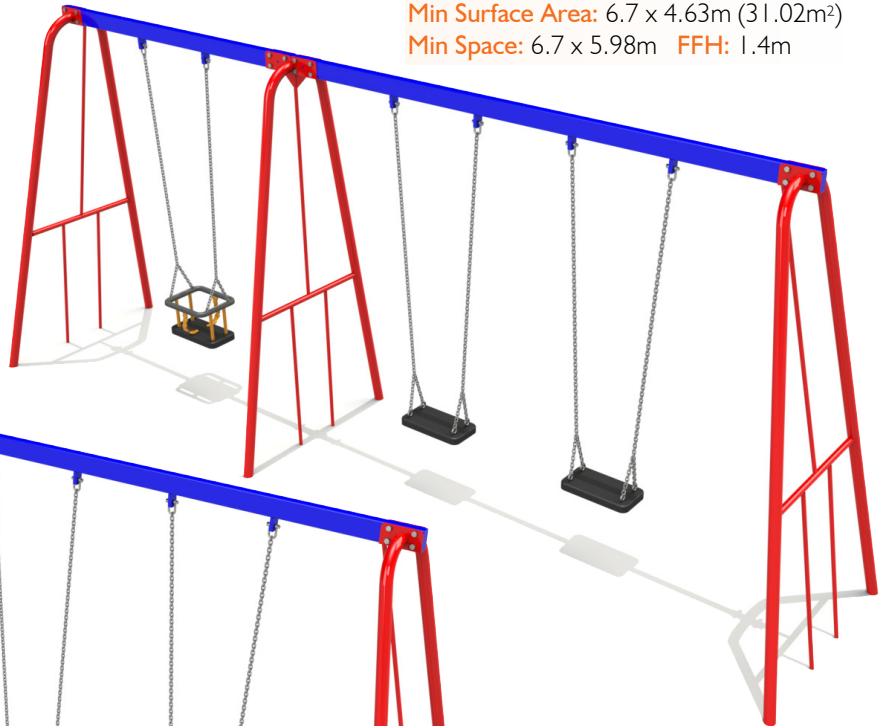

2.4m - 2 Flat & 1 Cradle Seats

L: 5980 W: 1300 H: 2510mm
 Min Surface Area: 6.7 x 4.63m (31.02m²)
 Min Space: 6.7 x 5.98m FFH: 1.4m



2.4m - 2 Flat & 2 Cradle Seats

L: 7110 W: 1300 H: 2510mm
 Min Surface Area: 6.7 x 5.76m (38.59m²)
 Min Space: 7.11 x 6.7m FFH: 1.4m

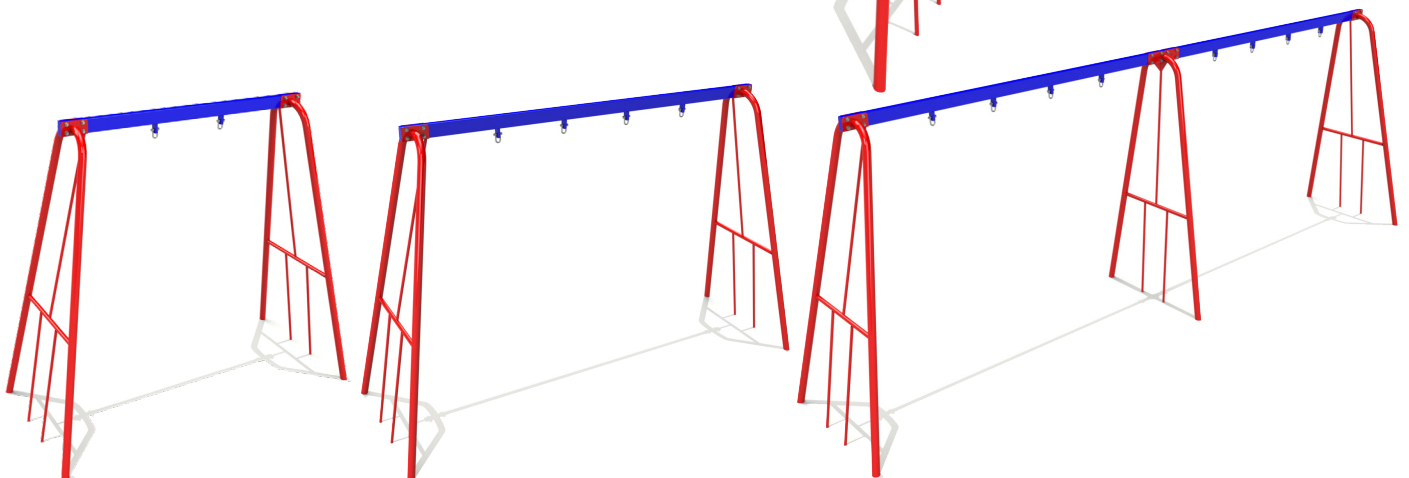

Steel Swing Frames available without seats and chains.

Frames come with all fixings and swing seat hangers. Universal joints and safety chains are not included with the group seat frames.



2.4m - 2 Flat & 1 Group Seat
 L: 7110 W: 1300 H: 2510mm
 Min Surface Area: 7 x 5.88m (41.16m²)
 Min Space: 7.2 x 7m FFH: 1.4m

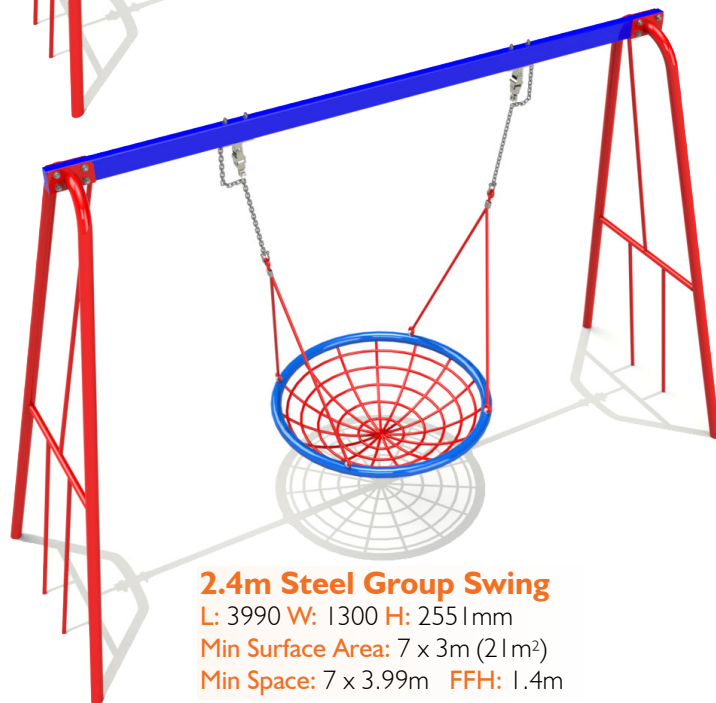

2.4m Steel Group Swing
 L: 3990 W: 1300 H: 2551mm
 Min Surface Area: 7 x 3m (21m²)
 Min Space: 7 x 3.99m FFH: 1.4m



2.4m - 1 Inclusive Seat
 L: 2820 W: 1300 H: 2510mm
 Min Surface Area: 7 x 1.8m (12.6m²)
 Min Space: 7 x 2.82m FFH: 1.4m



2.4m - 1 Inclusive & 1 Cradle Seat
 L: 3930 W: 1300 H: 2510mm
 Min Surface Area: 7 x 2.88m (20.16m²)
 Min Space: 7 x 3.99m FFH: 1.4m



2.4m - 1 Inclusive & 1 Flat Seat
 L: 3930 W: 1300 H: 2510mm
 Min Surface Area: 7 x 2.88m (20.16m²)
 Min Space: 7 x 3.99m FFH: 1.4m

Timber Seesaw

L: 2900 W: 280 H: 1100mm
 Min Surface Area: 5.93 x 3.18m (16.6m²)
 FFH: 1.1m

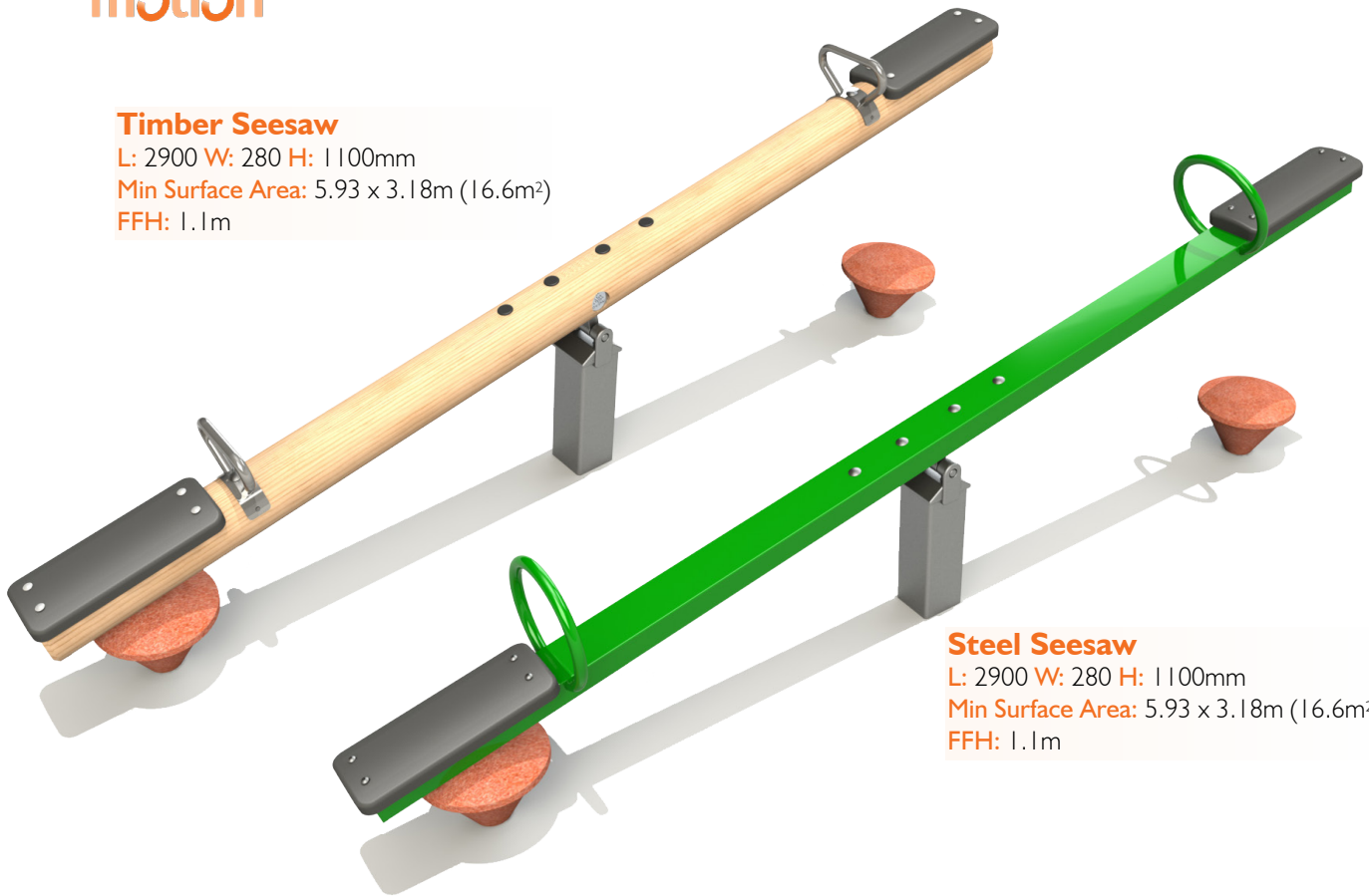

Steel Seesaw

L: 2900 W: 280 H: 1100mm
 Min Surface Area: 5.93 x 3.18m (16.6m²)
 FFH: 1.1m

Embankment Slides

Embankment Slides

Platform Dimensions
 L: 864 W: 614 H: 985mm

Slide Heights
 1m, 1.25m, 1.5m & 2m

Different HDPE colours available
 on request.



Bespoke units available on request

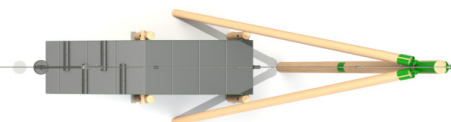
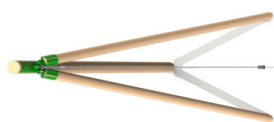

One Way Timber - 20m

L: 20000 W: 2100 H: 4100mm
 Min Surface Area: 24 x 4m (92m²)
 FFH: 1.25m

One Way Timber - 30m

L: 30000 W: 2100 H: 4100mm
 Min Surface Area: 34 x 4m (132m²)
 FFH: 1.25m

One Way Timber - 25m

L: 25000 W: 2100 H: 4100mm
 Min Surface Area: 29 x 4m (112m²)
 FFH: 1.25m

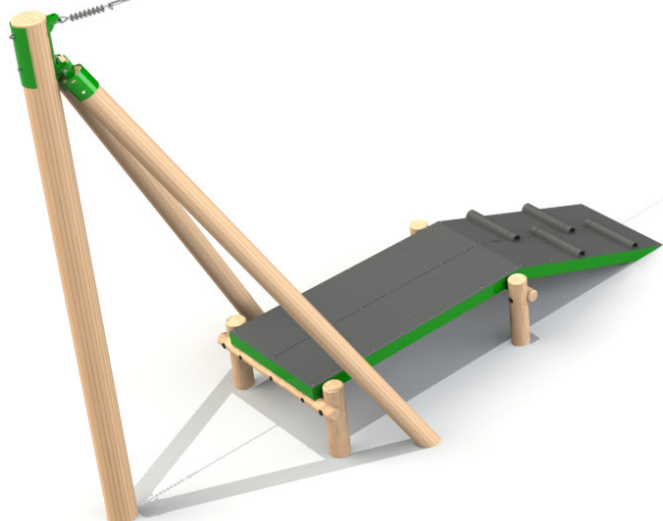
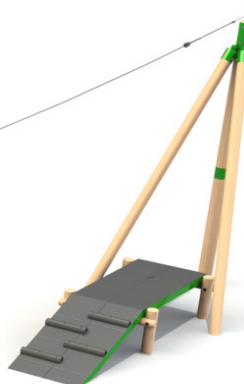
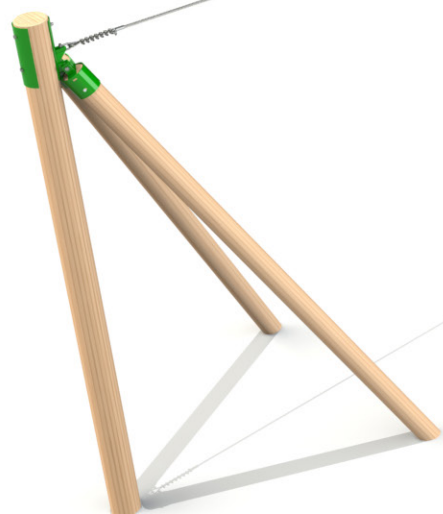

Two Way Timber - 20m

L: 20000 W: 2100 H: 4100mm
 Min Surface Area: 24 x 4m (92m²)
 FFH: 1.25m

Two Way Timber - 25m

L: 25000 W: 2100 H: 4100mm
 Min Surface Area: 29 x 4m (112m²)
 FFH: 1.25m

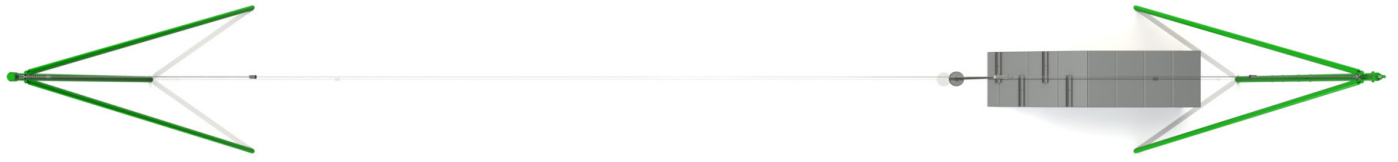

One Way Steel - 20m
 L: 20000 W: 2100 H: 3550mm
 Min Surface Area: 24 x 4m (92m²)
 FFH: 1.25m

One Way Steel - 25m
 L: 25000 W: 2100 H: 3550mm
 Min Surface Area: 29 x 4m (112m²)
 FFH: 1.25m

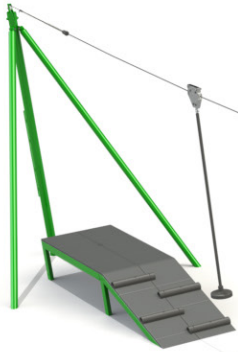

One Way Steel - 30m
 L: 30000 W: 2100 H: 3550mm
 Min Surface Area: 34 x 4m (132m²)
 FFH: 1.25m

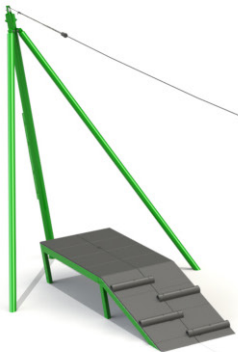

Two Way Steel - 20m
 L: 20000 W: 2100 H: 3550mm
 Min Surface Area: 24 x 4m (92m²)
 FFH: 1.25m

Two Way Steel - 25m
 L: 25000 W: 2100 H: 3550mm
 Min Surface Area: 29 x 4m (112m²)
 FFH: 1.25m

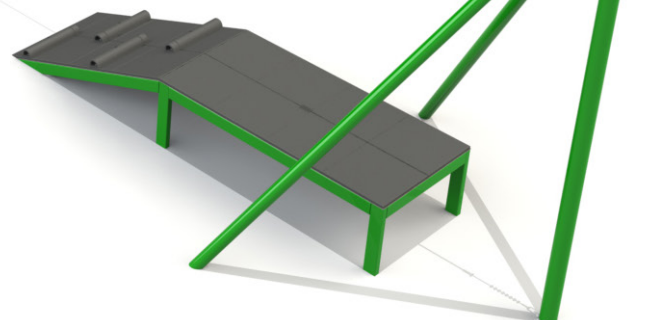



The ability to offer unrivalled value for money whilst still ensuring exceptional quality and longevity is key. The Play in Motion range accommodates all ages, budgets and play scheme sizes.

Our uncompromising approach to safety during the design and manufacturing process is paramount. With this in mind the Play in Motion range is designed to meet the requirements of BS EN 1176.

In order to ensure the highest level of accuracy, all units are produced on a custom made, state of the art, 6 Axis CNC machine.

This technology allows us to offer unparalleled accuracy in the field of play timber production.

Tel: 07929344505

Email: alex@rsjplay.co.uk

www.rsjplay.co.uk

RSJ Play Ltd, 3 Boscobel Road, Walsall, West Midlands, WS1 2PL